

# GRE PSR-500

ADVANCED DIGITAL HANDHELD SCANNING RECEIVER  
WITH OBJECT ORIENTED USER INTERFACE

## Owner's Manual

A Guide to Getting The Most From Your  
PSR-500 Advanced Digital Scanner



GRE America, Inc., 425 Harbor Blvd., Belmont, CA 94002

# **PSR-500 ADVANCED DIGITAL SCANNER WITH OBJECT ORIENTED USER INTERFACE**

OWNER'S MANUAL - Please read before using this equipment.

---

## IMPORTANT:

This manual uses the following symbols to emphasize Warnings, Notes and Usage Hints



### **WARNING**

A WARNING symbol is used to indicate possible risk of personal injury or damage to equipment



### **NOTE**

A NOTE symbol is used to indicate an operational note that relates to the current paragraph of the manual



### **HINT**

A HINT symbol is used to indicate a usage hint that relates to the current paragraph of the manual

Please take the time to read this manual completely before using your new scanner.

## IMPORTANT NOTICE:

The PSR-500 Advanced Digital Scanner will not receive encrypted radio communications, or radio transmissions that utilize ProVoice digital modulation.

FCC ID ADV0715

This device complies with part 15 of the FCC Rules. Operation is subject to the following two conditions: (1) This device may not cause harmful interference, and (2) this device must accept any interference received, including interference that may cause undesired operation.

Motorola, Smartnet, Smartzone, Omnilink, ASTRO and Privacy Plus are registered trademarks of Motorola Inc. EDACS and ProVoice are registered trademarks of MA-COM Inc. LTR is a registered trademark of E.F. Johnson, Inc. The IMBE™ voice coding Technology embodied in this product is protected by intellectual property rights including patent rights, copyrights and trade secrets of Digital Voice Systems, Inc. This voice coding Technology is licensed solely for use within this Communications Equipment. The user of this Technology is explicitly prohibited from attempting to decompile, reverse engineer, or disassemble the Object Code, or in any other way convert the Object Code into a human readable form. U.S. Pat. Nos. 5,870,405 and 5,517,511.

## Table of Contents

<b>Introduction.....</b>	<b>7</b>
<b>Features.....</b>	<b>8</b>
<b>Overview of the Object Oriented User Interface.....</b>	<b>10</b>
<b>Background.....</b>	<b>10</b>
<b>What is Object Oriented Scanning?.....</b>	<b>14</b>
<b>A Few Things To Remember about Object Oriented Scanning.....</b>	<b>15</b>
<b>About this manual.....</b>	<b>16</b>
<b>Object abbreviations used in this document.....</b>	<b>16</b>
<b>TGRP.....</b>	<b>16</b>
<b>TSYS.....</b>	<b>16</b>
<b>CONV.....</b>	<b>17</b>
<b>LMIT.....</b>	<b>17</b>
<b>SRVC.....</b>	<b>17</b>
<b>SWPR.....</b>	<b>17</b>
<b>The FCC Wants You To Know.....</b>	<b>17</b>
<b>Scanning Legally.....</b>	<b>18</b>
<b>Getting Familiar With Your PSR-500.....</b>	<b>20</b>
<b>PSR-500 Front View.....</b>	<b>20</b>
<b>PSR-500 Rear View.....</b>	<b>21</b>
<b>PSR-500 Included Accessories.....</b>	<b>22</b>
<b>Understanding the Display Icons.....</b>	<b>23</b>
<b>Understanding the Keypad.....</b>	<b>24</b>
<b>Softkeys.....</b>	<b>24</b>
<b>Five Way Pushbutton Pad.....</b>	<b>24</b>
<b>Numeric Keypad.....</b>	<b>24</b>
<b>Operation Keys.....</b>	<b>25</b>
<b>Getting Started.....</b>	<b>26</b>
<b>First Time Startup.....</b>	<b>26</b>
<b>Unpack the radio.....</b>	<b>26</b>
<b>Insert the batteries.....</b>	<b>26</b>
<b>Attach the antenna.....</b>	<b>27</b>
<b>Turn the radio on.....</b>	<b>28</b>
<b>Set the battery type, if necessary.....</b>	<b>28</b>
<b>Low Battery Warning.....</b>	<b>29</b>
<b>Battery Charge Indicator.....</b>	<b>29</b>
<b>Listening Safely.....</b>	<b>29</b>
<b>Traffic Safety.....</b>	<b>30</b>
<b>Connecting an Optional External Antenna.....</b>	<b>30</b>
<b>Connecting an Earphone/Headphones.....</b>	<b>31</b>
<b>Connecting an External Speaker.....</b>	<b>31</b>
<b>Using the Belt Clip.....</b>	<b>31</b>
<b>Using AC Power.....</b>	<b>32</b>

Using Vehicle Battery Power.....	32
Creating Your First New Objects.....	34
Conventional Channel Object (CONV).....	34
Essential Conventional Channel parameters.....	34
Talkgroup Object (TGRP).....	38
Essential Trunking Talkgroup parameters.....	38
Setting up and using a Trunking System (TSYS) object.....	38
Using DUPE to speed up object entry.....	43
Basic Scanning Operation.....	44
Browsing Objects.....	46
Advanced Startup Topics.....	46
About Object Numbering.....	47
Using the Object ID to directly access an object.....	47
More About Wildcard Scanning.....	47
Displaying Memory Usage.....	48
Search Object Types.....	48
Limit Search Object (LMIT).....	49
Essential Limit Search parameters.....	49
Spectrum Sweeper Object (SWPR).....	50
Essential Spectrum Sweeper parameters.....	51
Service Search Object (SRVC).....	53
Essential Service Search parameters.....	53
Grouping Objects with Scan Lists.....	55
Geographically.....	55
By trunking system.....	56
By object type.....	56
By application.....	56
By Favorites.....	56
Mapping Objects to Scan Lists.....	57
Naming, enabling and disabling Scan Lists.....	58
Other Advanced Startup Topics.....	60
Finding Stored Objects Easily.....	60
Searching For Objects Using FIND.....	60
Filtering By Object Type.....	61
Object Lockout.....	61
Temporary Lockout.....	61
Permanent Lockout.....	63
Search Lockout.....	63
Talkgroup Lockout.....	64
Setting the Default Scan List.....	65
Deleting Objects.....	66
Using Multi-Site Mode On Networked Systems.....	66
LTR Home Repeater AutoMove.....	68
Priority Scan.....	68
Turning Object Priority On or Off.....	69
Turning Priority Scan Mode On or Off.....	69

CONV Priority Scan.....	69
TGRP Priority Scan.....	69
Hit Counters.....	70
Audible Alarms and the ALERT LED.....	70
Audible Alarm and ALERT LED Settings.....	71
ALERT LED with Audible Alarm Examples.....	71
Dedicated search modes.....	72
Using Dedicated Spectrum Sweeper (SWPR) Mode.....	72
Using dedicated TUNE mode.....	74
Using dedicated Limit and Service search modes.....	76
LMIT Search Mode.....	76
Using dedicated SRVC mode.....	77
Using Weather Modes.....	79
Weather Radio Mode.....	80
Weather Priority Mode.....	80
SAME Standby Mode.....	81
SAME Entry Examples.....	82
Entering SAME Location and Event Codes.....	83
Activating SAME Standby Mode.....	86
Using V-Scanner Storage.....	86
Saving Main Memory To A V-Scanner Folder.....	88
Loading A Stored V-Scanner Folder To Main Memory.....	88
Erasing V-Scanner Folders.....	89
Cloning Your Radio to Another PSR-500 or PSR-600 Scanner.....	89
Standard Text Entry Method and QuickText.....	89
Entering and Editing Alphanumeric Information.....	90
Using QuickText.....	91
Customizing QuickText.....	92
Power-On Configuration Key Sequences.....	93
Birdie Frequencies.....	94
Care.....	95
In Case of Fault.....	95
Troubleshooting.....	96
Troubleshooting Chart.....	96
Initializing Global Parameters to Factory Defaults.....	96
Initializing the Scanner to Factory Defaults.....	97
Detailed Menu Reference.....	99
GLOB Menu Reference.....	100
CONV Menu Reference.....	103
TGRP Menu Reference.....	105
TSYS Menu Reference.....	107
LMIT Menu Reference.....	109
SRVC Menu Reference.....	111
SWPR Menu Reference.....	113
Appendix A - Remote Control Protocol.....	115
Get Status.....	116

Get LCD.....	116
Send Key.....	117
Tune.....	118
Appendix B - CCDump.....	119
Appendix C - Frequency, Step and Mode Specifications.....	122
Appendix D - General Specifications.....	123
Appendix E - About Trunked Radio Technologies.....	126
Appendix F - About CTCSS, DCS and P25 NAC.....	129
CTCSS.....	129
DCS.....	130
P25 NAC.....	130
Appendix G - Finding More Information.....	131
Learning About Scanning and your PSR-500.....	131
Finding Frequencies and Trunked System Information.....	131
Index.....	133
Warranty.....	137

## Introduction

Welcome to an exciting new world of radio scanning! Recognizing that contemporary scanning receivers are too hard to program and use, GRE's engineers conducted extensive research to determine the functional requirements for an entirely new scanning receiver user interface. We call this new user interface the Object Oriented User Interface (OOUI), and it is based on the premise that, to a hobbyist, a scanner is easiest to use if all of the things that can be scanned are handled using common conventions for interaction between the user and the radio, at least to the extent that this is possible given that the "things" that can be scanned are different from one another in either subtle or major ways.

In this new user interface design, we call "things" that can be scanned **Scannable Objects**. Simply put, a Scannable Object is defined as **something that can be scanned or monitored**. Scannable Objects include the following:

- Conventional, non-trunked radio channels
- Trunked talkgroups used on a trunked radio system
- Service searches to search for a specific radio service
- Search ranges with upper and lower limits
- Spectrum Sweeper setups with band segments that can be enabled or disabled by the user

One of the goals of the Object Oriented User Interface is to make the scanner as easy to use as possible. The OOUI does this by treating all Scannable Objects the same in terms of how they are created, edited, manipulated and grouped. Once you have learned how to create and store a conventional channel, you know most of what you need to know to create a trunking talkgroup, and so on.

While we have designed this radio to be the easiest scanning receiver in its class to program and use, we encourage you to read this manual in its entirety so that you will fully understand all of the radio's capabilities. However, if you consider yourself to be an experienced scanning hobbyist and are feeling adventurous, we invite you to dive right in and get started programming your favorite "objects" into the radio.

## Features

**Upgradeable CPU and DSP Firmware** - keep your radio current with enhancements as they become available with free upgrades from [www.greamerica.com](http://www.greamerica.com)!

**Intuitive "Object Oriented" User Interface Design** is designed for ease of use, yet powerful enough to satisfy the most sophisticated experts. Common data entry, browsing and control methods are used for non-trunked conventional channels, trunking talkgroups, search configurations and Spectrum Sweeper setups. The radio grows with you – you can start out with a small, easy to manage configuration, then expand it whenever you need to.

**Menu Driven Programming With Context Sensitive Help** - Each menu item provides a few lines of help text that provide assistance with programming and using the scanner.

**Powerful and flexible Scan List functionality** allows you to arrange, group and scan objects according to your preference.

**Flexible Free-Form Memory Organization** - memory is assigned as objects are created using a sophisticated internal file management system. You are not constrained to traditional bank/channel scanner memory layouts. No memory is wasted as a result of bank/channel programming constraints. The scanner has sufficient main memory capacity to store over 1,800 conventional channels, trunking talkgroups, search configurations and Spectrum Sweeper objects in any combination, providing ample capacity for more sophisticated hobbyists and professionals while keeping the database size manageable for beginners.

**GRE's Exclusive V-Scanner Technology** - Allows you to save complete radio configurations within the radio, for recall into main memory as needed in the field. This is similar to having a laptop computer and programming software available anytime. You can use V-Scanners to store configurations for different geographical areas or usage styles. Twenty one V-Scanner Folders are provided, each capable of storing over 1,800 objects. Total memory capacity of main memory combined with V-Scanners is over 37,800 objects!

**SKYWARN Storm Spotter Functionality** - Instant access to frequencies used by storm spotter networks. You can monitor storm conditions as they occur, and become aware of dangerous



conditions before the media or emergency management officials are able to announce them to the general public.

**SAME and All Hazards Weather Alerting** - Your scanner can operate in dedicated Specific Area Message Encoding (SAME) weather alerting mode, and alert you to severe weather and other hazards in the specific area(s) that you select, or, your scanner can check your local NOAA weather frequency periodically, even while scanning and alert you when an All Hazards alert occurs.

**Multi-System Trunking** - Scans most common trunked radio system signaling formats, including Motorola, EDACS, LTR and P25 trunked radio networks. Both talkgroup and individual call monitoring are supported.

**GRE's Exclusive Automatic Adaptive Digital Tracking** - When monitoring P25 digital systems, instantly adapts the digital decoder to the digital modulation format of the transmitted signal, then analyzes the signal over 50 times each second and adapts to any subtle changes caused by multipath or fading. No cumbersome manual adjustments are required.

**GRE's Exclusive Digital AGC** - instantly compensates for low user audio levels that are very common on digital systems. This makes the radio easier to listen to, and provides you with a more enjoyable scanning experience.

**LTR Home Repeater AutoMove** - Takes the guesswork out of programming LTR trunking systems when the home repeater order is not known. Enter the LTR system frequencies in any order, and the PSR-500 will automatically move the frequencies to the proper home repeater slots as transmissions are received on the system.

**The Best Subaudible Squelch Decoder in the Scanning Industry** - CTCSS and DCS subaudible squelch coding is processed by the same powerful DSP chip that is used for P25 digital decoding. Provides fast and reliable decoding of subaudible squelch signaling with squelch tail elimination.

**Powerful Spectrum Sweeper** - Quickly sweeps the scanner's frequency ranges for transmissions from nearby sources. When a nearby active frequency is found, the scanner automatically tunes to that frequency and receives the traffic.

**P25 NAC Functionality** - Much like CTCSS and DCS with analog signals, P25 Network Access Code (NAC) is used to provide selective squelch operation on conventional digital channels. Your PSR-500 will detect the NAC that is being used on a P25 conventional digital channel, and allow you to program NAC codes to block transmissions that do not have a matching NAC, including analog traffic on the same frequency!

**Exclusive ALERT LED** - Programmable tri-color LED can be configured to illuminate or flash when certain objects are active. Eight user-defined colors and brightness levels can be specified from thousands of possible combinations. Provides visual alerts when certain channels are active, e.g., blue can be used to signal activity on your primary police channel, red for fire, etc.

**Audible alarms** - Programmable audible alarms can be configured to sound when certain Scannable Objects are active. Can be used in conjunction with, or separately from, the ALERT LED described above.

**High Speed PC Interface** - uses GRE's 30-3290 USB cable in full duplex mode at 6 times the speed of previous scanner models for PC transfer and 8 times the speed of previous models for radio to radio cloning.

**Real-time Signal Strength Indicator** – shows relative strength of received signals.

**Sleek, compact case design with large speaker** is designed for one-handed operation and ease of use.

## ***Overview of the Object Oriented User Interface***

### **Background**

Long time scanner enthusiasts probably remember the days before microprocessors became common in everyday consumer devices. Back then, scanners had very limited capabilities. A typical scanner was able to scan between 2 and 10 frequencies, and relied on plug-in crystal elements for each frequency that a user wished to scan. Scanning activity was typically shown on a row of incandescent or LED indicators. These indicators would show scanning operation in progress as the scanner moved from one channel to the next, looking for activity, and would indicate the active channel when activity was found. Pushbuttons or switches were used to skip or lock out undesired channels. The scanning row of LEDs or incandescent indicators seemed to

personify the hobby at the time, and it was quite an experience to see the light show from multiple radios in a well-equipped scanner shack

Early microprocessor controlled scanners eliminated the need for crystals and increased the number of channels that could be scanned. Without keypads and numeric or alphanumeric displays these early microprocessor controlled radios still relied on the traditional row of lights to show scanning activity. A row of switches was used to enter binary code to store individual frequencies. In some later models a punch card or metal comb was used to load the binary code.

The true predecessors of today's modern scanning receivers are those first radios to use a numeric keypad to store frequency information and control the radio, and numeric LCDs to show the programmed information and display the status of the radio. The row of lights was replaced with a row of zeroes or other display elements in the LCD to show scanning activity.

As it became possible to increase the memory capacity of these microprocessor controlled scanners, designers started looking for ways to organize this expanded memory to make operation easier for users. This led to the typical bank/channel memory organization that is still used in many scanning receivers today. This design works well when scanning conventional, non-trunked frequencies.

Trunking presented new challenges for designers. Early trunking scanner designs operated in trunking or conventional mode, but not both at the same time. Because programming for trunked systems includes many parameters not normally used in conventional radio scanning, it was necessary to design a completely separate user interface for entering trunking parameters and scanning trunked systems. Soon after the first early models were released, new "multi-scanning" receivers appeared that allowed users to scan different combinations of trunked systems or conventional channels simultaneously.

Trunking scanners soon earned a reputation for being complex and difficult to program. Even experienced and expert users were frustrated when confronted with the challenges of programming and operating a trunked scanning receiver. Part of the problem with trunking scanners was the way that trunking functionality was added to the radio. Until recently, trunking functionality was forced into the traditional bank/channel scanner design. This confused and frustrated users, who had to learn two

different methods for programming and controlling their scanners – one for conventional, non-trunked channels, and another for trunked systems and talkgroups.

GRE's engineers carefully studied the challenges of programming and operating today's current crop of trunked scanning receivers. We have also carefully studied how scanning hobbyists like to use their radios, and the role the Internet plays in the scanning hobby. We have studied the scanning hobby itself, which has changed dramatically over the years as radio systems, scanning receivers and scanner hobbyists have all become more sophisticated. Sophistication is a generally good thing, but in this case it can have the effect of discouraging newcomers from joining the hobby.

Our engineers decided that an entirely new method of programming and controlling scanning receivers was needed – essentially, a new user interface. Several design objectives were defined. These included the following:

- There should be a strong focus on ease-of-use. The radio should do as much work as possible for the user. A brand new hobbyist should be able to begin using the radio quickly with minimal frustration. There should also be enough advanced features and functionalities to satisfy the most sophisticated expert users.
- The user interface should be intuitive. Interactions with the radio should be standardized to the extent possible. For example, the same basic methods should be used whether adding a new conventional channel or adding a trunked talkgroup.
- The scanner should include efficient memory usage. Bank/channel designs result in much wasted memory. Memory should be allocated as it is needed for new Scannable Objects.

Our engineers realize that our scanners are used by a wide variety of users with varying levels of experience and expertise. These include amateur radio operators, scanner hobbyists, fire buffs, railfans, public safety professionals, volunteer firefighters, news and media organizations, and most importantly, everyday people who just want to know what is going on around them.

All of these users share a few things in common about the way they use scanning receivers. First, they all follow the same basic

process when configuring and programming the radio for use. Second, all have one or more collections of frequencies, talkgroups, or other things they listen to.

As our engineers studied the scanning hobby and those who use scanners, they began to realize that the scanning hobby had much in common with hobbies that involve collections, like stamp collecting, coin collecting, and so on.

Hobbies of collection all have some things in common:

- Typically, a collector starts off small, and adds to the collection
- A collector groups items in the collection according to their type
- A collector looks for new things to add to the collection
- A collector removes items from the collection that they no longer desire
- A collector enjoys the collection

Specifically, with regard to scanning:

- At first, the typical scannist starts off small, and expands. This is especially true with beginners and newcomers to the hobby.
- The scannist groups channels and talkgroups according to area or type of use
- The scannist searches or tunes to find new things to scan
- A scannist removes channels and talkgroups they no longer need
- A scannist enjoys the collection of channels and talkgroups they have programmed into the scanner

Our engineers determined that a new scanner design would be most useful if it could be used as a tool by the scanning hobbyist to build and enjoy the collection of channels and trunked talkgroups they have programmed into the scanner.

Much of what you see in the design of your new GRE scanner with Object Oriented User Interface is intended to meet the

objectives we describe above, and serve as a tool to help you manage and enjoy your collection of “Scannable Objects”.

## **What is Object Oriented Scanning?**

To put it simply, Object Oriented Scanning describes a new user interface design for scanning receivers (the Object Oriented User Interface, or OOUI). In Object Oriented Scanning, we introduce the concept of the Scannable Object. A Scannable Object is defined as “something that can be scanned”.

The Scannable Object concept is very important in the OOUI design. Recall that one of the more frustrating things about current trunking scanners is that entirely different methods of programming and interacting with the radio are used depending on whether the user is working with trunking talkgroups or conventional channels. A method that works with one does not work well with the other. The user must learn two entirely different “languages” for “talking to” the radio – one for trunking and one for conventional, non-trunked frequencies.

What if it was possible to use the same basic “language” regardless of whether a user is working with trunked talkgroups or conventional channels, such that once a user has learned how to enter a conventional channel into memory, they already know most of what they need to know to enter a trunked talkgroup? Or, a search range, or other “Scannable Objects”? This is how the OOUI works – the two primary Scannable Objects, talkgroups on trunked radio systems and conventional non-trunked frequencies use the same user interface elements.

Additionally, we include limit and service search configurations and Spectrum Sweeper configurations as Scannable Objects. This means that it is possible to create, edit, group, scan and delete service and limit searches, and Sweeper configurations using the same methods that are used when working with trunked talkgroups and conventional channels.

Object Oriented Scanning also lends itself quite well to the “collector hobbyist model” we describe above. Object Oriented Scanning makes it very easy for newcomers to the hobby or the radio to start off with a small collection of scannable objects and expand their collection as needed later. Object Oriented Scanning makes it easy to group Scannable Objects in Scan Lists, a powerful and flexible grouping system. Object Oriented Scanning makes it easy to search for new frequencies or talkgroups to monitor, and add them to existing or new Scan List

groups. Object Oriented Scanning makes it very easy to delete or deactivate objects and Scan Lists that you do not want to listen to, including a powerful temporary lockout mode that allows you to zero in on activity associated with a specific incident, then restore your desired configuration when the incident is over. Finally, Object Oriented Scanning makes it exceedingly easy for the scannist to enjoy the collection of channels and talkgroups they have programmed into the scanner, and to share them with other scannists.

## **A Few Things To Remember about Object Oriented Scanning**

Object oriented scanning is completely different from any prior scanning receiver technology. Accordingly, some users may find it difficult to visualize and understand how Object Oriented Scanning works. This may be especially true for users who have become very familiar with more recent scanning receiver technologies.

We suggest that you keep the following "OOUI Tenets" in mind as you proceed with your study of this manual. If you find yourself confused or stuck about the basics of Object Oriented Scanning, it may be helpful to review this section again.

1. The OOUI memory organization is nothing more than a large list of "Scannable Objects".
2. A "Scannable Object" is simply "something that can be scanned", including conventional channels, trunking talkgroups, limit searches, service searches and Spectrum Sweeper setups.
3. In OOUI scanning, there are no "systems", "banks", "groups", "sub-groups" or "ID lists". There is simply a very large collection of objects, each with their own attributes. Scannable Objects all exist at the same level or hierarchy within the scanner - no single type of Scannable Object is more important than another, and Scannable Objects do not have dependencies on or links to other Scannable Objects in order for them to function properly.
4. The primary method of grouping the collection of objects is by mapping them to Scan Lists. Mapping a Scannable Object to one or more Scan Lists does not change the physical location of the object in the memory system. Even when an object is mapped to one or more Scan Lists, the object itself has not

moved nor changed from what it is - a simple, standalone object that is part of a larger collection.

## ***About this manual***

### **Object abbreviations used in this document**

We described how your new GRE scanner utilizes an Object Oriented User Interface in the Introduction and Overview sections of this manual. You learned that the key components of this new user interface are the Scannable Objects, which are, of course, “things that can be scanned”. As you begin to use your new scanner, you will notice that the object names are abbreviated so that they can easily fit into the 16 character LCD. (Imagine what the radio’s display would look like if “Trunking Talkgroup Object” was spelled out in its entirety every time it was necessary to show it in the display.)

You should take a moment and become familiar with these abbreviations now. For consistency, the same abbreviations for the different object types are used in the radio and here in the manual.

#### ***TGRP***

**TGRP** is used to represent a Trunking Talkgroup Object. Trunking Talkgroups are “virtual” channels that exist on a trunked radio system. A trunked radio system is a radio system where a small group of radio channels are automatically shared between a larger number of users and user groups. This sharing of channels is managed automatically by a special computer, called a **controller**, or by other specialized hardware. For now, all you need to know is this; if you want to monitor a talkgroup on a trunked radio system, you must store that talkgroup’s parameters in a TGRP object.

#### ***TSYS***

**TSYS** is used to represent a Trunking System Object. A TSYS is a special object type that is used when creating TGRP objects. A trunking talkgroup must be associated with a specific trunked radio system in order for it to operate. There are parameters that are associated with trunking systems, such as the type of trunked radio system technology used, the frequencies that the system uses to broadcast control data, etc. Instead of entering these parameters over and over again every time you create a new TGRP on the same trunked radio system, you create a TSYS object with all of the system parameters, then specify that



TSYS object for each TGRP you create on the same trunked radio system. A TSYS cannot be scanned by itself and is not considered a Scannable Object. It is a “configuration object” that can be used over and over again when adding talkgroups for a specified trunked radio system.

## **CONV**

**CONV** is used to represent a Conventional Channel Object. A Conventional Channel Object is a regular, non-trunked frequency used for radio communications. CONV objects are used to store the parameters for any radio channel that is not a part of a trunked system. For example, if you want to monitor specific VHF marine channels, they should be programmed as CONV objects. If you want to monitor your favorite amateur radio channel, it should be stored as a CONV object. If your police or fire department uses a channel, or channels that are not trunked, but part of a “plain old radio system”, they should be stored as CONV objects.

## **LIMIT**

**LIMIT** is used to represent a Search Range, or Limit Search Object. LIMIT objects contain the parameters necessary for the radio to search a range of individual frequencies between a lower and upper limit frequency.

## **SRVC**

**SRVC** is used to represent a Service Search Object. SRVC objects are further divided into Public Safety, Aircraft, Amateur, CB, Marine, and FRS/GMRS/MURS/DOT. SRVC objects are similar to LIMIT objects, but are preprogrammed to search all frequencies associated with the selected service. For example, selecting the Amateur SRVC search will search selected amateur radio frequency ranges in the VHF and UHF portions of the radio spectrum.

## **SWPR**

**SWPR** is used to represent a Spectrum Sweeper Object. SWPR objects contain the parameters necessary for the radio to rapidly sweep a range of radio spectrum for strong signals from nearby transmitters.

## ***The FCC Wants You To Know***

This equipment has been tested and found to comply with the limits for a scanning receiver, pursuant to Part 15 of the FCC Rules. These limits are designed to provide reasonable

protection against harmful interference in a residential installation. This equipment generates, uses and can radiate radio frequency energy and, if not installed and used in accordance with the instructions, may cause harmful interference to radio communications.

However, there is no guarantee that interference will not occur in a particular installation. If this equipment does cause harmful interference to radio or television reception, which can be determined by turning the equipment off and on, the user is encouraged to try to correct the interference by one or more of the following measures:

- Reorient or relocate the receiving antenna.
- Increase the separation between the equipment and receiver.
- Connect the equipment into an outlet on a circuit different from that to which the receiver is connected.

This device complies with Part 15 of the FCC Rules. Operation is subject to the following two conditions:

1. This device may not cause harmful interference.
2. This device must accept any interference received, including interference that may cause undesired operation.

## ***Scanning Legally***

Your scanner covers frequencies used by many different groups including police and fire departments, ambulance services, government agencies, private companies, amateur radio services, military operations, pager services, and wireline (telephone and telegraph) service providers. It is legal to listen to almost every transmission your scanner can receive. However, there are some transmissions you should never intentionally listen to. These include:

- Telephone conversations (cellular, cordless, or other means of private telephone signal transmission)
- Paging transmissions
- Any intentionally decoded scrambled or encrypted transmissions

According to the Electronic Communications Privacy Act (ECPA), you are subject to fines and possible imprisonment for intentionally listening to, using, or divulging the contents of such a transmission unless you have the consent of a party to the communication (unless such activity is otherwise illegal).

This scanner has been designed to prevent reception of illegal transmissions. This is done to comply with the legal requirement that scanners be manufactured so as to not be easily modifiable to pick up those transmissions. Do not open your scanner's case to make any modifications that could allow it to pick up transmissions that are illegal to monitor. Doing so could subject you to legal penalties.

We encourage responsible, legal scanner use.

In some areas, mobile use of this scanner is unlawful or requires a permit. Check the laws in your area. It is also illegal in many areas to interfere with the duties of public safety officials by traveling to the scene of an incident without authorization.

## Getting Familiar With Your PSR-500

The following illustrations are provided to help you get familiar with your PSR-500's controls and accessories.

### PSR-500 Front View



Figure 1 - PSR-500 front view

## PSR-500 Rear View

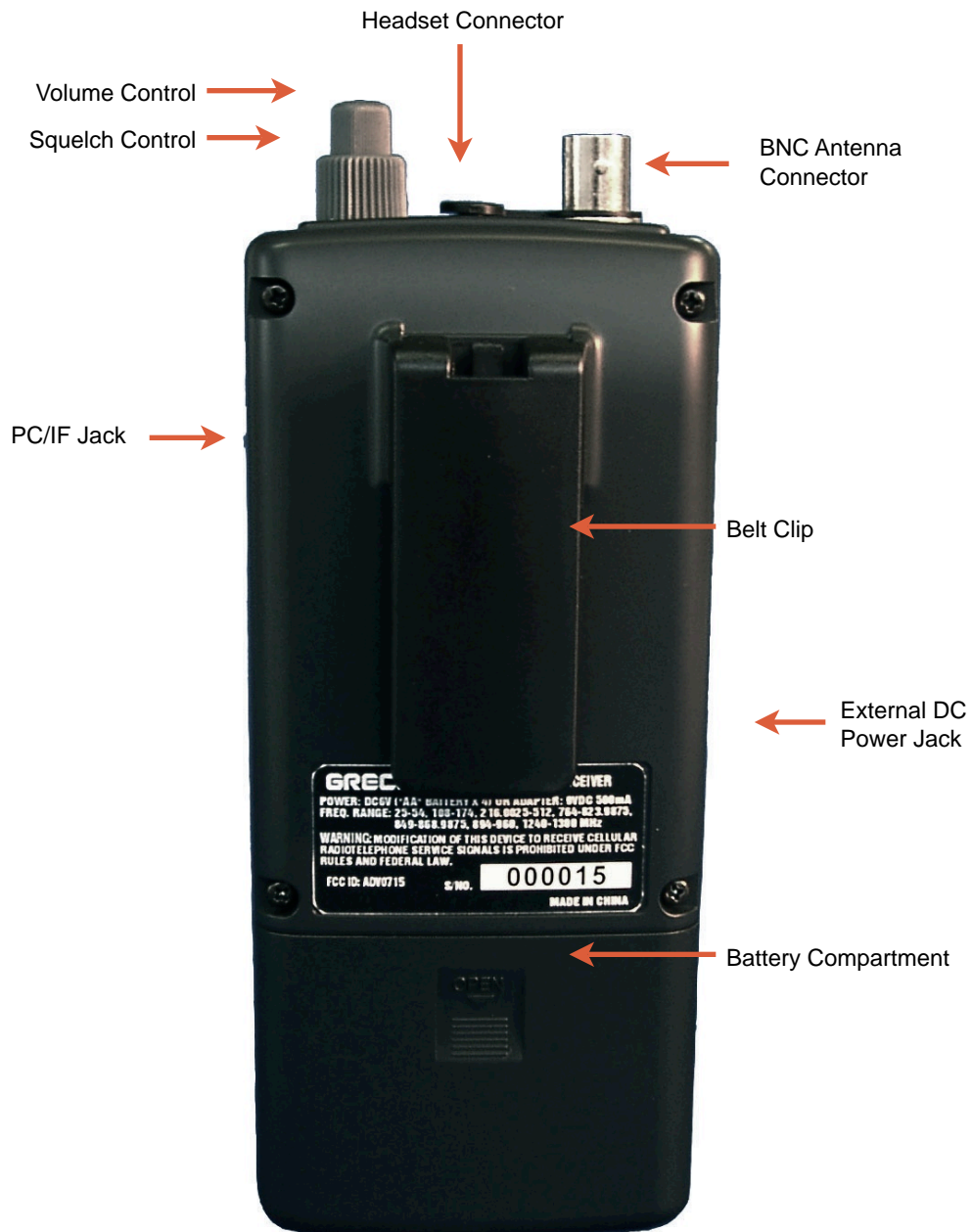

Figure 2 - PSR-500 rear view

## PSR-500 Included Accessories

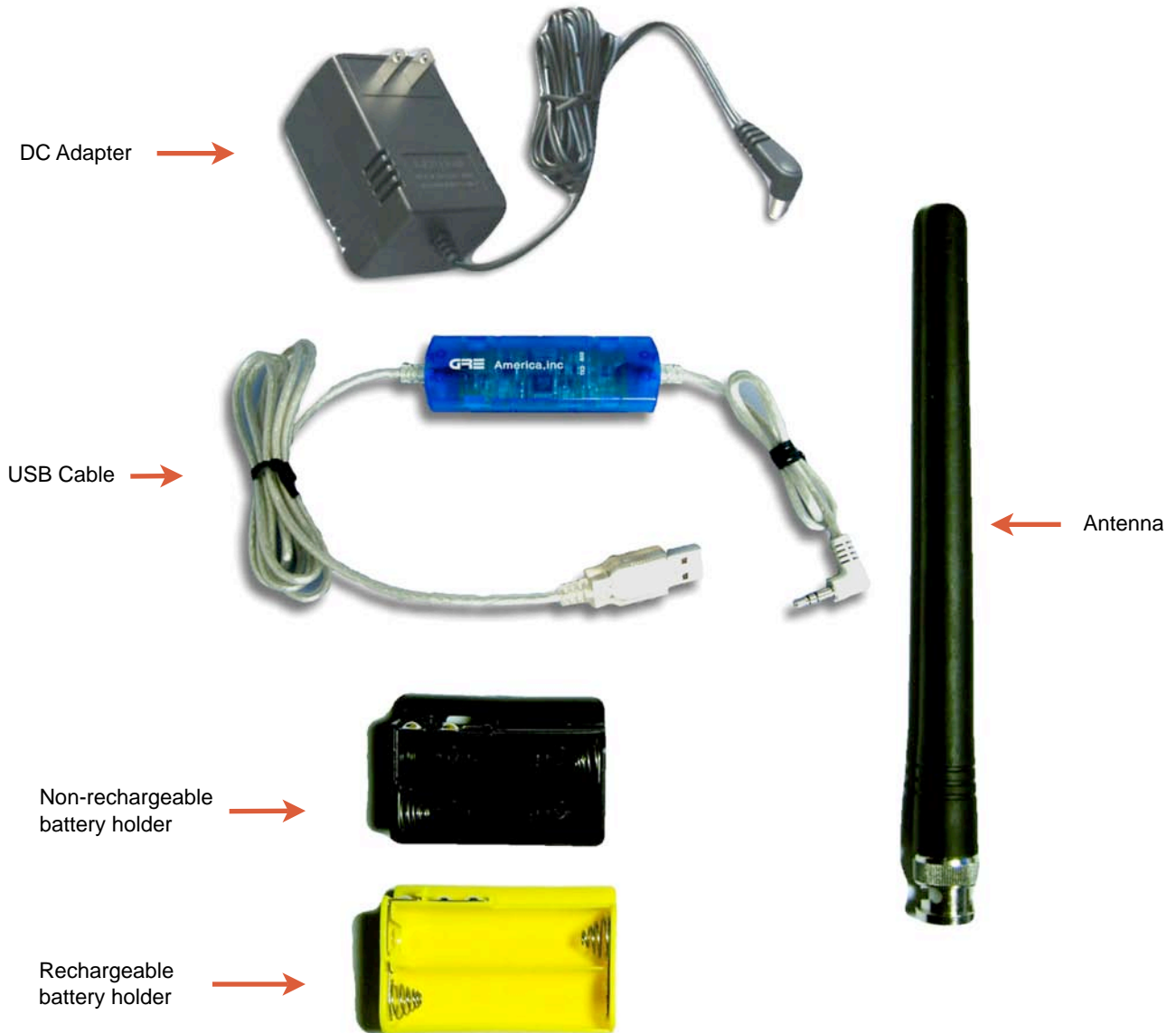

Figure 3 - PSR-500 Included Accessories (Compact Disc not shown)

## Understanding the Display Icons

Your PSR-500 features a high contrast, backlit Liquid Crystal Display (LCD) to provide important information about the status of the radio while you are programming and using it. The LCD includes a row of icons at the top that provides information about the status of the scanner while it is operating. Beneath this row of icons, there are 4 rows of 16 characters each that provide alphanumeric information for frequencies, object names, Scan List status and menu information. Figure 4 provides an example of the display that is shown while the radio is scanning.

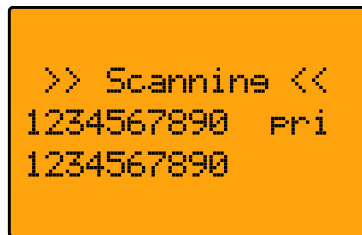

Figure 4 - Scanning Display

The top row of icons are defined as follows:

**F** The Function Key ( **FUNC**) has been pressed. **FUNC** acts as a “shift” key and typically enhances in some way the action of the button that follows it. When using **FUNC**, press the **FUNC** key first and release it, then press the next key.

**T** The scanner is currently receiving trunking control channel data.

**G** The attenuator is set for Global mode.

**A** The attenuator is currently active.

**S** The radio’s squelch circuit is open.

 Signal meter indicating strength of the received signal.

 Battery status indicator. Comes on solid when battery is weak, and flashes two times each second when battery failure is imminent. Briefly flashes approximately once every second when the radio is connected to external power and the internal battery charger circuit is active.



**NOTE:** The “internal battery charger circuit active” indicator provides an indication that the battery charger circuit is active, and does not provide positive indication that the batteries are actually being charged. Batteries will not charge unless the yellow battery holder is used.

▲ ▼ Menu position and search direction indicators.

## Understanding the Keypad

Your PSR-500 features an easy-to understand backlit keypad with 34 keys that are used to control and program the radio. Figure 5 highlights the various keys and their basic functions.



Figure 5 - Keypad layout

### Softkeys

F1, F2, F3 - activate function shown in the LCD display immediately above the softkey.

### Five Way Pushbutton Pad

◀ ▶ ▲ ▼ keys are used for navigation while browsing objects and menus. SEL key activates data entry fields and toggles Scan List selection in object menus. FUNC SEL activates context sensitive help in menus.



### Numeric Keypad

Used for data entry of frequencies, talkgroup IDs and alphanumeric labels. Used while scanning, 1-9 and 0 toggle Scan Lists 1-10 on and off. FUNC 1-9 and 0 toggle Scan Lists 11-20 on and off.



## Operation Keys

FUNC - activates alternate key functions. FUNC key operation is very intuitive - typically it “amplifies” the keypress that follows it.

 - activates backlight, FUNC  locks keypad.

MAN - Places scanner in Manual Mode for monitoring single objects.

SCAN - Places scanner in Scan Mode for scanning enabled objects, FUNC SCAN launches Spectrum Sweeper.

TUNE - Allows direct tuning of any valid frequency, FUNC TUNE loads the current or most recently scanned frequency into TUNE

SRCH - Dedicated Search mode for service and frequency searches

ATT - Toggles Attenuator on and off, FUNC ATT toggles Global Attenuator mode

PRI - Toggles the Priority setting for selected or active object, FUNC PRI toggles Priority Mode on or off for the scanner

FAV - Activates Favorites Scan Mode, FUNC FAV adds the current object to the Favorites Scan List

WX - Activates Weather scan, FUNC WX activates Skywarn mode

PGM - Places scanner in Program Mode for editing radio-wide options, adding new objects or editing existing objects, FUNC PGM accesses V-Scanner mode

L/OUT - Toggles Temporary Lockout on active or selected object, FUNC L/OUT applies permanent lockout (can be changed in the GLOB menu)

ENT - Enter key

PSE - Pauses scan or search operation on active object

# Getting Started

## First Time Startup

We believe that your new PSR-500 is so easy to use that scannists with minimal experience in the hobby should be able to get up and running in a matter of just a few minutes. If you already know the difference between a conventional channel and a talkgroup, or a search range and a Spectrum Sweeper, we invite you to dive right in and set the radio up to begin scanning your first objects. If you get stuck, you can refer to this Getting Started section, or see the relevant sections in the Detailed Menu Reference. Otherwise, please read on and allow us to help you get acquainted to your new scanner!



*WARNING: Always protect your scanner from exposure to extreme heat or cold temperatures.*



*WARNING: Your scanner is not waterproof. Do not expose it to rain, extreme high humidity or moisture.*



*WARNING: The external DC power input is designed to accept 9 VDC using a tip-positive coaxial power plug. Do not connect the radio to external power sources that are greater than 9 VDC. Ensure that the DC polarity is correct before connecting your radio to an external power source. Turn the radio off prior to connecting or disconnecting external power.*

## Unpack the radio

Unpack your radio carefully. Save all documentation and packing materials in case it is necessary to return your scanner for repair.

## Insert the batteries

Remove the door covering the battery compartment by pressing gently where the door is marked **OPEN** and sliding the door downwards until it stops, approximately 1/4". Lift the door away from the radio. Select the correct battery holder for the type of batteries you are going to use. Use the black battery holder for non-rechargeable batteries, and the yellow battery holder for rechargeable batteries.

Insert four AA batteries into the holder, taking care to ensure that the batteries are inserted according to the polarity diagram shown inside of the holder assembly. Insert the holder into the

battery compartment, then replace the battery compartment door by placing it back over the batteries and sliding it upward gently until it locks in place.



*NOTE: Two battery holders are included with your PSR-500. The black battery holder should be used with non-rechargeable alkaline batteries. The yellow battery holder should be used with rechargeable NiMH or NiCAD batteries. The radio will charge the batteries when the yellow holder is used in conjunction with the supplied AC adapter or other external 9 VDC power supply rated at 500 mA. If desired, you may use rechargeable batteries in the black holder. They will not be charged while installed in the radio.*



*WARNING: Never place non-rechargeable batteries in the yellow holder. Intentionally or accidentally recharging non-rechargeable batteries will cause them to overheat, leak or explode. Dispose of rechargeable batteries properly by taking them to an approved battery recycling facility. Many communities offer battery recycling services - check with your local solid waste management agency.*



*WARNING: Always remove old or weak batteries. Batteries can leak chemicals that destroy electronic circuits. Always turn off the scanner when not in use to prevent deep discharge and possible battery leakage. Do not mix old and new batteries, different types of batteries (alkaline, or rechargeable), rechargeable batteries of different capacities or rechargeable batteries with different charge states. If you do not plan to use the scanner with batteries for a month or longer, remove the batteries. Batteries can leak chemicals that can destroy electronic parts. When you charge Ni-Cd batteries, do not overcharge them. Overcharging shortens battery life.*



*WARNING: Do not allow metal objects such as key rings, necklaces, coins, etc., to touch the (+) and (-) terminals of the battery holder when batteries are installed. Shorting the (+) and (-) terminals of the battery holder will destroy the batteries and cause a fire. Discontinue use of any battery that exhibits leakage, swelling or abnormal generation of heat.*

## Attach the antenna

Remove the antenna from its protective plastic wrapper. Align the slots on the antenna's BNC male connector with the posts on the radio's BNC female connector and slide the antenna in place,

then rotate the antenna's BNC connector 1/4 turn clockwise until it snaps in place.



*NOTE: If desired, you may also connect a mobile or base station antenna equipped with a BNC male connector to the antenna connector*

## Turn the radio on

Rotate the top knob of the VOLUME/SQUELCH control clockwise to turn the radio on. Set both the VOLUME and SQUELCH knobs at their mid-point (12 o'clock) position.



*NOTE: While 12 o'clock is a good squelch setting to start with, it may cause your radio to miss some calls with weak signals. You will probably want to optimize the squelch setting to set it close to threshold. To optimize the squelch setting to be close to the best threshold, press TUNE, then rotate the squelch control counterclockwise until a rushing sound is heard from the speaker. Rotate the squelch control clockwise just past the point where the rushing sound stops. The squelch is now set to the optimum point. Please note the position of the squelch control for future reference. Once the squelch setting is complete, you may press PGM to exit TUNE mode.*

## Set the battery type, if necessary

By default, your new scanner is configured to use standard alkaline batteries. Specifying the proper type of battery is necessary for proper operation of the low battery detection feature, and also enables the charge circuit if you are using rechargeable batteries.

If you are not using alkaline batteries, you should change the battery type by following these steps:

1. Press the PGM key.
2. Press the F3 key, which should show the label **GLOB** immediately above it in the LCD display.
3. Press the ▼ nine times, or until the middle line of the display reads **Battery:Alkaline**.
4. Press the ◀ or ▶ to select the type of batteries that are installed in the radio. Use **Alkaline** for standard alkaline batteries, **NiCad** for nickel-cadmium rechargeable batteries, and **NiMH** for nickel-metal hydride rechargeable batteries.

5. Press the F1 key (the **SAVE** softkey) to save your battery settings to the radio's configuration memory.

### **Low Battery Warning**

Your scanner will provide two warnings when the batteries are low. The first warning will typically occur approximately 15 to 30 minutes prior to the point where the batteries are completely depleted, and is indicated by a solid battery icon in the top row of the LCD display. The second warning will typically occur approximate five minutes before the batteries are completely depleted, and is indicated by a flashing battery icon (approximately two flashes per second) in the top row of the LCD display, and an audible low battery alert every 30 seconds.



*NOTE: Actual timing of low battery warnings will depend on the age and condition of the batteries you are using.*

### **Battery Charge Indicator**

Your scanner provides an indication when the internal battery charge circuit is active. The battery icon briefly flashes approximately once every second when the radio is connected to external power and the internal battery charger circuit is active.



*NOTE: The "internal battery charger circuit active" indicator provides an indication that the battery charger circuit is active, and does not provide positive indication that the batteries are actually being charged. Batteries will not charge unless the yellow battery holder is used.*

### **Listening Safely**

To protect your hearing, follow these guidelines when you use headphones.

Set the volume to zero before putting on headphones. With the headphones on, adjust the volume to a comfortable level.

Avoid increasing the volume once you set it. Over time, your sensitivity to a volume level decreases, so volume levels that do not cause discomfort might damage your hearing.

Avoid or limit listening at high volume levels. Prolonged exposure to high volume levels can cause permanent hearing loss.

## Traffic Safety

Wearing headphones while operating a motor vehicle or riding a bicycle can create a traffic hazard and is illegal in most areas.

Even though some headphones let you hear some outside sounds when listening at normal volume levels, they still can present a traffic hazard. Exercise extreme caution!

## Connecting an Optional External Antenna

The antenna connector on your scanner makes it easy to use the scanner with a variety of antennas, such as an external mobile antenna or outdoor base station antenna.

Always use 50-ohm coaxial cable, such as RG-58 or RG-8 low-loss dielectric coaxial cable. If your antenna's cable does not have a BNC connector, you will also need a BNC adapter. Follow the installation instructions supplied with the antenna, route the antenna cable to the scanner, then connect it to the antenna jack.



*WARNING: Use extreme caution when installing or removing an outdoor antenna. If the antenna starts to fall, let it go! It could contact overhead power lines. If the antenna touches a power line, touching the antenna, mast, cable, or guy wires can cause electrocution and death. Call the power company to remove the antenna. DO NOT attempt to do so yourself.*



*WARNING: Outdoor antennas must be properly grounded to prevent static buildup and lightning damage. Article 810 of the National Electrical Code, ANSI/NFPA 70, provides information about proper grounding of the antenna mast, connection of coaxial cable to a lightning arrestor, size of grounding conductors, location of the lightning arrestor and connection of grounding conductors to grounding electrodes. Additionally, you may wish to disconnect your radio from the outdoor antenna during electrical storm activity to prevent damage. The diagram below provides an example of a proper antenna grounding system.*

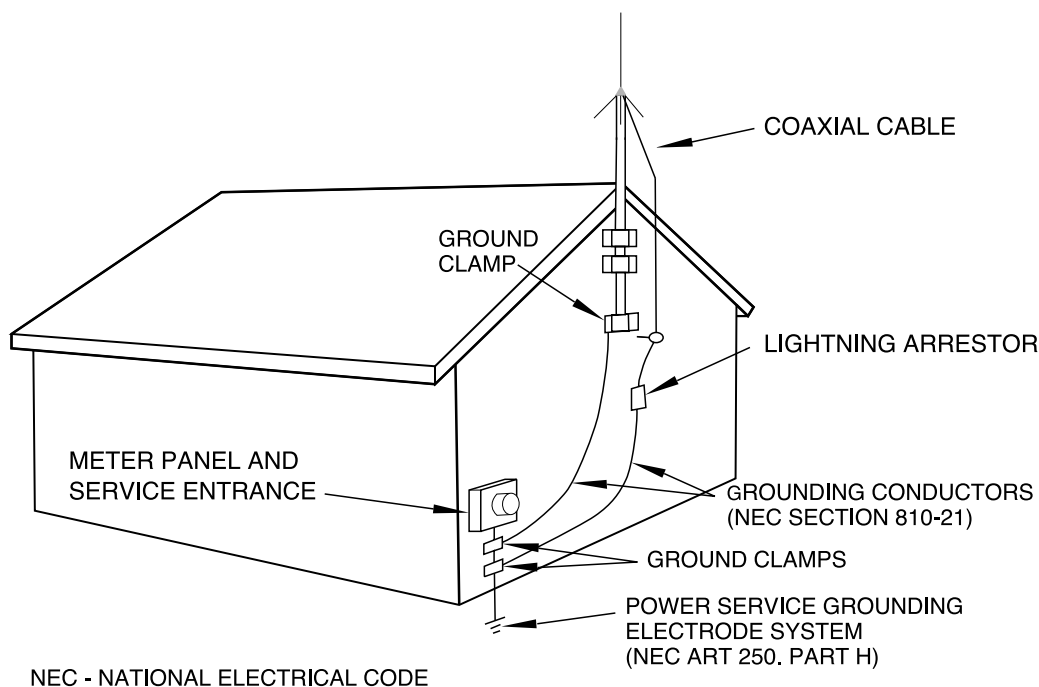

## Connecting an Earphone/Headphones

For private listening, you can plug an 1/8-inch (3.5 mm) mini-plug earphone or headphones (not supplied) in the HEADPHONE jack on top of your scanner. This automatically disconnects the internal speaker.

## Connecting an External Speaker

In a noisy area, an amplified speaker (not supplied) might provide more comfortable listening. Plug the speaker cable's 1/8-inch (3.5 mm) mini-plug into your scanner's HEADPHONE jack.



*NOTE: You must use an amplified speaker with this scanner. Non-amplified speakers do not provide sufficient volume for comfortable listening.*

## Using the Belt Clip

You can use the belt clip attached to the back of the scanner for hands-free carrying when you are on the go. The PSR-500 ships with the belt clip already installed. To remove the belt clip, use your finger to disengage the retaining catch at the top of the belt clip from the back of radio, and slide the belt clip upwards. To install the belt clip, slide it down into the belt clip receptacle on

the rear of the radio. Press down on the belt clip until it locks in place. Slide the belt clip over your belt, pocket or waistband.



**NOTE:** You can order a replacement belt clip from GRE America (<http://www.geramerica.com>) if the one that came with your radio becomes lost or damaged.

## Using AC Power

You can power the scanner using a supplied AC adaptor.



**WARNING:** You must use the supplied AC adaptor.

- Always connect the AC adaptor to the scanner before you connect it to AC power. When you finish, disconnect the adaptor from AC power before you disconnect it from the scanner.
- The correct orientation for the enclosed power adaptor is in a vertical or floor-mount position.

To power the scanner using an AC adaptor, connect the plug into the scanner's PWR DC 9V jack. Then connect the AC adaptor to a standard AC outlet.



**WARNING:** To prevent electric shock, do not use the AC adaptor's polarized plug with an extension cord, receptacle, or other outlet unless you can fully insert the blades to prevent blade exposure.

## Using Vehicle Battery Power

You can power the scanner from a vehicle's 12V power source (such as cigarette-lighter socket) using a 9VDC at least 500-mA adaptor with 4.75mm outer/1.7mm inner plug. Its center tip must be set to positive and its plug must fit the scanner's PWR DC 9V jack. Using an adaptor that does not meet these specifications could damage the scanner or the adaptor.



**WARNING:** Always connect the DC adaptor to the scanner before you connect it to the power source. When you finish, disconnect the adaptor from the power source before you disconnect it from the scanner.

To power the scanner using a DC adaptor, connect the plug into the scanner's PWR DC 9V jack. Plug the other end of the DC adaptor into your vehicle's cigarette-lighter socket.





*NOTE: If you use a cigarette-lighter power cable and your vehicle's engine is running, you might hear electrical noise from the engine while scanning. This is normal.*

## Creating Your First New Objects

When the scanner is first turned on after it is unpacked, you are working with a clean slate. You will notice that your scanner tells you this:

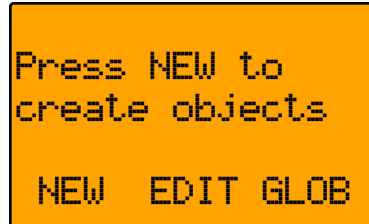

The scanner is in program mode and is ready for you to enter the first Objects into the memory. The scanner prompts you to Press NEW to create objects.

You will also notice that there are three pushbutton keys beneath the display, and above each button in the display, a label that indicates the current function of these three keys. These keys are called **softkeys**, and they function much like the softkeys on many Automatic Teller Machines. Their meaning can change depending on the operational state that the radio is in. Right now, the softkeys on your radio should read as follows:

NEW EDIT GLOB

Let's focus on the NEW softkey for a few minutes. As you might have guessed, NEW is an invitation for you to create a new Scannable Object (CONV, TGRP, LMIT, SRVC, or SWPR). So, what would you like to create first? We suggest that you start with a Conventional Channel Object (CONV) first, to get familiar with the radio's user interface and display.

### Conventional Channel Object (CONV)

A Conventional Channel Object (CONV) is a record that stores the parameters for a regular, non-trunked conventional AM or FM channel. When you create a CONV object, you are creating an object that will allow you to scan and monitor a "plain old radio channel", that is, a single frequency and the associated parameters that are necessary for you to receive traffic on that frequency.

#### *Essential Conventional Channel parameters*

CONV objects are the simplest objects supported by the radio. By this we mean that there really isn't that much for you to do if

you want to create one. There are only a few essential parameters in the CONV object fields that must be set correctly for a CONV object to work. The Frequency must be set to match the frequency of the transmitter you want to scan or monitor, and the MODE should be set to AU, or, if desired, AM, FM or NFM. Note that the scanner will automatically select the default mode based on the frequency you enter when MODE is set for AUto. In most cases it will not be necessary to change this.

We also recommend that you label your CONV object by giving it a name in the TAG field. This will make it easier for you to find the CONV object later, and identify it when the scanner stops to monitor activity. Enter your CONV object by following these steps.

As we mentioned above, a brand new radio will launch into Program Mode when it is first turned on, which allows for creation and editing of Scannable Objects. If this is the first time you have turned on your radio, you should see these softkey labels at the bottom of your screen:

```
NEW    EDIT    GLOB
```

If not, press the PGM (Program) key now.

Press the NEW softkey to begin entry of a new object.

Press the CONV softkey to begin entry of a CONventional Channel object. Your scanner's display should read as follows:

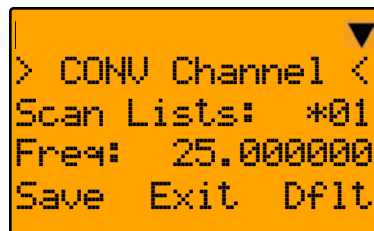
A screenshot of a scanner's monochrome display. The screen shows a menu for a 'CONV Channel' object. At the top, there is a right-pointing chevron '>' followed by 'CONV Channel' and a left-pointing chevron '<'. Below this, the text 'Scan Lists: \*01' is displayed. The next line shows 'Freq: 25.000000'. At the bottom of the screen, three softkey labels are visible: 'Save', 'Exit', and 'Dflt'. A small downward-pointing triangle icon is located in the top right corner of the display area.

Now, take a moment and study the display. You will notice that the ▼ icon is active. Its purpose is to indicate that you are at the very top position of the menu for a conventional channel object, and there are more parameters that can be accessed if you scroll down. We also see three new softkeys:

```
Save   Exit   Dflt
```

The Save softkey will save your new CONV object to the file system when pressed (but don't press it yet!). The Exit softkey

aborts the creation of the new CONV object, and the **DfIt** softkey restores the selected CONV menu parameter to its default setting.

If you press the **▼** key on the bottom of the 5-way pushbutton pad, you can scroll down and see all of the parameters that can be specified for a CONV object. Go ahead and take a peek - then scroll back to the very top of the display so you can begin entering information for your first CONV object.



*HINT: Pressing **FUNC ▲** or **FUNC ▼** will jump to the top or bottom of a menu, respectively.*

Note that as you scroll both the upward and downward scroll indicators will illuminate to indicate that there are parameters above and below the current cursor position, until you get to the very end of the menu, where only the upward scroll indicator will be on to indicate that there are no more parameters below the current cursor position. Also note that a few lines of context sensitive help are available for each menu item. To see the help text for a menu item, press **FUNC**, then press **SEL** on the 5-way pushbutton pad. To exit help, press **SEL** again.

As you scroll the object menu, you will see a line that states:

**▼ ▼ EXPERT BELOW ▼ ▼**

This line is found in the object menus and the Global configuration menus. Its purpose is to delineate between the basic settings that are important to each object and the operation of the radio, and the expert settings that may be of interest to advanced users, but, if left alone, will not adversely impact the operation of the radio. For more information about the Basic and Expert settings, please refer to the Detailed Menu Reference at the end of this Owner's Manual.

Use the **▲ ▼** keys to scroll the screen until the flashing cursor appears next to the **Freq:** label. Key in a known local frequency and press the **ENT** key, or press the **DONE** softkey - either one

will do the same thing. There! You just entered the frequency for your first CONV object.

By default, your new CONV object will be tagged “Channel”. If you’d like to change this, just scroll the screen down one click until the flashing cursor highlights the **Tag** field, then press **SEL** to edit the tag. You can move the cursor around using the **◀ ▶** keys on the 5-way pushbutton pad, use the **CL** key to clear the old text, or press **FUNC CL** to erase the entire field. To enter text, find the letter you want to enter on the front panel of the radio, press the numeric key beneath it, then press 1, 2, 3, or 4 depending on the position of the letter in the group for that number. For example, to enter FIRE, press:

```
3 3 F
4 3 I
7 3 R
3 2 E
```

Press the **ENT** key or **DONE** softkey to store the new tag information for your CONV object.

Now you are ready to store your first CONV object. There are other parameters that you can change, and we invite you to scroll through the CONV menu to see the other settings that are available. You can experiment with the different settings. If you make a change that you aren’t certain about, press the **Deflt.** softkey to restore the setting to its original values.

When you’re ready, simply press the **Save** softkey to save your new conventional object. Once the object is saved, you can continue to enter other new objects, or press **MAN** to listen to the CONV object you just entered, or **SCAN** to start scanning!



*NOTE: Your scanner uses Scan Lists as a way to group objects together according to your preferences for scanning. By default, all new objects are mapped to Scan List 01. There are a total of twenty regular Scan Lists in your radio, a special Favorites Scan List, and a Scan List to hold Skywarn objects. Scan List membership for an object is assigned in the individual object menus. For now, just let your new objects go to the default Scan List 01. Later in this section we will show you how you can group your objects into Scan Lists.*



*NOTE: When entering data into a numerical field, you can start typing as soon as you have scrolled to the desired field, which will replace the*

the contents of the field with your new entry. Alternatively, you can press  
▶ key, which will preserve the original contents of the field so  
you can make small changes without retyping all of the data.

## **Talkgroup Object (TGRP)**

A Trunking Talkgroup Object (TGRP) is a record that stores the parameters for a trunked talkgroup on a trunked radio system. When you create a TGRP object, you are creating an object that will allow you to scan and monitor a talkgroup on a particular trunked radio system.

### ***Essential Trunking Talkgroup parameters***

As a standalone object, a TRGP object is really no more complicated than a CONV object. The trunking system (TSYS) that the TGRP is a member of must be specified. Each talkgroup has a digital “address” on the trunking system, which is called the talkgroup ID, and this must be provided. We also recommend that you label your TGRP object by giving it a name in the TAG field. This will make it easier for you to find the TGRP object later, and identify it when the scanner stops to monitor activity.

### ***Setting up and using a Trunking System (TSYS) object***

We just mentioned that the TSYS is an essential parameter needed in order for a TGRP object to function properly and receive radio traffic. The TSYS object has its own set of essential parameters, and these parameters vary depending on the type of trunked radio system you plan to monitor. If you are a reasonably experienced user you probably already know what the essential parameters are for the system you wish to monitor. For example, each TSYS must correctly specify the type of system being monitored, the control channel or LCN frequencies used by the system, and so on. A detailed description of each type of system supported by this radio and the essential parameters required to make the different types of trunked radio systems work properly is provided in the Detailed Menu Reference. So, if all of this makes sense to you then you should proceed and enter the required data for the system you wish to monitor to make a new TSYS as you create your TGRP. If not, please refer to the TGRP section of the Detailed Menu Reference so that you will understand which TSYS parameters are required for the type of trunked radio system you wish to monitor.

The first time you make a TGRP for a particular trunked radio system, you must also create a TSYS that contains the system parameters associated with that trunked radio system. Once you create a TSYS object for the trunked radio system, you can use

the TSYS object over and over again without having to re-enter all of the system data.

Assuming that you have already entered one or more CONV objects (which we recommend you do prior to attempting the entry of the slightly more complicated TGRP object), you should press the PGM key to place your scanner into Program Mode, then press the NEW softkey, then press the TGRP softkey. Your radio display should appear as follows:



```
> Talkgroup <
Scan Lists: *01
TSYS:      NEW
Save Exit Dflt
```

In the same way as with the CONV object, this menu of TGRP parameters can be scrolled up and down to access and enter or change the various parameters associated with a trunking talkgroup.

For the purpose of this example, we will assume that you wish to create a TGRP object for a Motorola Type II 800 MHz trunked radio system, which is one of the more common types of trunked radio systems in use. (If this is not the case, we encourage you to refer to the Detailed Menu Reference section of this manual for more information that applies to the type of TSYS you wish to monitor.)

Scroll the display by pressing the down arrow once so that the flashing cursor is highlighting the TSYS field, then press the SEL key in the center of the 5-way pushbutton pad. Your radio's display should appear as follows:

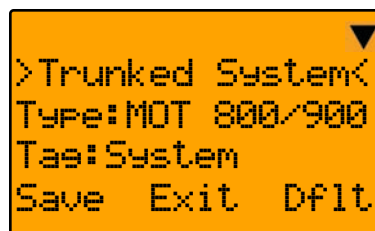

```
>Trunked System<
Type:MOT 800/900
Tas:System
Save Exit Dflt
```

We are entering a new Motorola Type II 800 MHz system, so we can leave the TYPE# field as-is. It's a good idea (in fact, a REALLY good idea, for reasons you will see as you proceed) to give your TSYS a unique name. Press the down arrow key once

to scroll to the **Tag:** field, then press the **SEL** key and enter a name for the system using the methods previously described for naming your CONV object. We will use the tag **My System** for this particular example in the documentation:

```
6 1 M
9 3 Y
. <space>
7 4 S
9 3 Y
7 4 S
8 1 T
3 2 E
6 1 M
```

If necessary, use the decimal/period key or the **CL** key to delete any unnecessary characters, and press the **SAVE** softkey to save your **TSYS** name. Next, scroll to the **Frequencies:** field to begin entering the control channel frequencies for the **My System** trunked radio system. Press the **SEL** key, and at the **Ch01:** field you should enter the first control channel frequency for your Motorola trunked radio system. Simply key in the frequency including the decimal point, and press the **ENT** key or the **DONE** softkey to store the control channel frequency. Press the **▼** key and repeat this step to add any other control channels used by the system. Typically, a Motorola trunked radio site or system will have one active control channel and three backup control channels. You need only enter the active control channel for the scanner to track the system, but if the system switches to a backup control channel the scanner will not receive traffic unless the frequency for the backup control channel has been entered.

Once you have finished entering the control channels, press the **SAVE** softkey, then press the **SAVE** softkey again. This will store the new **TSYS** into memory and return you to the **TGRP** parameter entry. Your display will now appear as follows:

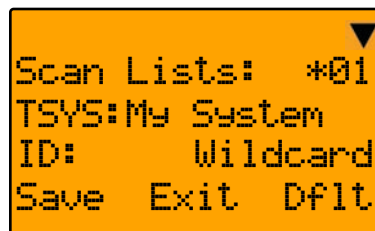

A screenshot of a scanner's display screen. The screen is orange with black text. At the top right, there is a small black triangle pointing downwards. The text on the screen reads: "Scan Lists: \*01", "TSYS: My System", "ID: Wildcard", and "Save Exit Dflt".



Notice that the system name has changed to reflect the name you chose when you were entering the parameters for the trunking system. As you enter this TGRP and other TGRP objects for this system, you will just specify the system name here. So, the TSYS parameters for a system need only be entered once. You simply specify the already-entered TSYS as needed when building more TGRP objects for the same system.

Scroll down one click to the **ID:** field. Note that by default, the trunking talkgroup ID is set to **Wildcard**. Wildcard is a special type of TGRP object that allows you to monitor all talkgroup call traffic on the associated trunked radio system. Wildcard TGRP objects allow you to quickly find and store new or unknown talkgroups on a trunked radio system. When a Wildcard TGRP object is mapped to an active Scan List and scanned, all talkgroup traffic on the system is monitored, and you have the option to save or lock out new talkgroups as they appear. You may wish to save your TGRP object as a Wildcard with no further changes. If so, just press the **SAVE** softkey to store your new TGRP as a wildcard. By default it will take the tag name of **ID: Wildcard**.



*HINT: Wildcard objects are easier to find and change later if you include an abbreviated name for the system in the tag field.*

If you would rather store a TGRP object for a specific talkgroup ID on MySystem, just press the number keys to enter the talkgroup ID of the desired talkgroup, then press the **ENT** key or the **DONE** softkey to store the ID.



*HINT: TGRP objects are also used to receive Private/Individual Calls on trunking systems that support these call types. Simply change the **TYPE:** field from Group to Private. A Wildcard TGRP object with the **TYPE:** field set to Private will monitor all Private/Individual Calls seen on the system, or you can specify a radio ID to watch for in the **ID:** field.*

You'll want to scroll down two more clicks to the **Tag:** field and enter an easy to remember name for your talkgroup that corresponds with its purpose on the trunked radio system. For this example, let's assume that this is a police dispatch talkgroup, and we would like to use the name "POLICE DISPATCH" for the tag. Scroll to the **Tag:** field and press the **SEL** key on the 5-way pushbutton pad. Using the text entry methods that you have previously employed for naming your

CONV and TSYS objects, name your new talkgroup "POLICE DISPATCH":

```
7 1 P
6 3 O
5 3 L
4 3 I
2 3 C
3 2 E
. <space>
3 1 D
4 3 I
7 4 S
7 1 P
2 1 A
8 1 T
2 3 C
4 2 H
```

Press ENT or DONE to store the name, then press SAVE to store the TGRP as a new object. As with the other object types, there are many other parameters you can edit for the TGRP, but for now, that's all you have to do to start monitoring traffic on that TGRP! To add more TGRPs on the same system, follow the same steps above, this time specifying the TSYS that you just created. To create TGRPs on a different system, follow the steps above, specify a NEW system, and provide the correct parameters for that system, as shown above.

As a reminder, here are a few important points to remember about monitoring trunked radio systems, and about TGRP objects in particular:

With regard to trunked radio systems, it is important to note that a "system" cannot be scanned. If one wishes to monitor radio traffic on a trunked radio system, one must create a TGRP object. A TGRP object includes the parameters for a trunked radio system so that it will operate properly. Trunking system (TSYS) parameters are stored as a separate "configuration object", and can be used over and over again in other talkgroup objects on the same trunked radio system.

Also with regard to trunked radio systems, it is important to note that a talkgroup object may be configured in one of four different

ways to monitor traffic on a trunked radio system. They are as follows:

- **Wildcard Talkgroup:** will monitor all talkgroup call radio traffic on the desired trunked radio system (press **Dflt** in the **ID:** field of the TGRP object to use Wildcard)
- **Talkgroup with TGID:** will only monitor talkgroup call radio traffic on the specified TGID (enter the desired talkgroup in the **ID:** field of the TGRP object to scan a specified ID)
- **Wildcard Private Call:** will monitor all private call radio traffic on the desired trunked radio system (press **Dflt** in the **TGID** field to get Wildcard, and set the **Type** field to **Private**)
- **Private Call with ID:** will only monitor private call radio traffic on the specified TGID (enter the desired Radio ID in the **TGID** field, and set the **Type** field to **Private**)



*NOTE: Remember, by default all new objects are mapped to Scan List 01. For now, just let your new objects go to the default Scan List 01.*

*Later in this section we will show you how you can group your objects into Scan Lists.*

## Using DUPE to speed up object entry

DUPE is a powerful feature that will help you when entering multiple objects that have similar characteristics. DUPE is especially useful when entering multiple TGRP objects that are hosted on the same trunked radio system, or multiple CONV objects that have similar parameters or tag names. To use DUPE, press the **PGM** key, then scroll to the object that you wish to duplicate using the **◀ ▶ ▲ ▼** keys on the 5-way pushbutton pad. Press the **EDIT** softkey, then press the **DUPE** softkey. An exact copy of the object you selected is created, and the scanner displays the newly created object menu so you can change the parameters that need to be changed prior to saving. Be sure to change the tag name before saving your new object. When finished, press the **SAVE** softkey to save the new object.

Try using the DUPE feature now to enter a few more CONV and TGRP objects before continuing. You might consider using DUPE on your wildcard TGRP object to make a duplicate, then set the **Type** to **Private**, so you'll have a TGRP wildcard for talkgroup calls, and another for private calls.



**NOTE:** Use caution with DUPE. As soon as you press DUPE, a duplicate of the selected object is created and saved in memory. Be certain to delete any DUPEd objects that you create accidentally.

## Basic Scanning Operation



Now that you have entered a few CONV or TGRP objects you can experiment with Scan and Manual operation.

Activating Scan Mode will cause your scanner to scan through all Scannable Objects that are members of enabled Scan Lists and are not locked out. Manual Mode allows you to browse the Scannable Objects you have created so you can select just one to monitor.

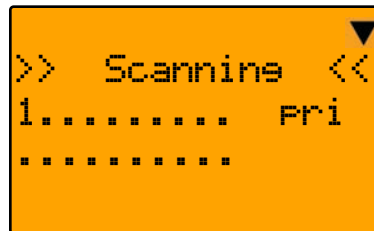
To activate Scan Mode, just press the SCAN key on the keypad. Unless you have explicitly changed Scan List membership, all of the objects you have entered so far should be mapped to Scan List 01, and your scanner should begin scanning these objects immediately when you press the SCAN key. The scanner display indicates Scan Mode as follows:



Study the two rows under the “Scanning” display. Each space represents the status of a Scan List in your radio. The top row of numbers represents Scan Lists 1 through 10, and the bottom row represents Scan Lists 11 through 20. Unless you have already enabled other Scan Lists in your radio, you will only see the number “1” in the top row. All of the other spaces contain “.” symbols, which indicates that these other Scan Lists are currently not enabled.

If you have included one or more TGRP objects in your programming, and are within range of the trunked radio system for those TGRPs, you will see the  icon flash periodically while the radio is scanning. The  icon indicates that the scanner is receiving control channel data from a trunked radio system.

To pause the scanner on an active object so that the scanner does not resume scanning, press the PSE (Pause) key while the scanner is stopped on that object, and press PSE or SCAN to

resume scanning. Alternatively, you may press MAN to monitor an active object. Although PSE and MAN both stop the scanner on the active object, there are some small differences in how they operate. PSE pauses the scanner but keeps the scanner in scan mode, resulting in faster stop/start operation. MAN stops scan mode completely, and allows you to browse the file system to select other objects to monitor.

While the scanner is Manual Mode, you can browse through the stored objects in your scanner and select one object to monitor. Use the ▲ and ▼ keys on the 5-way pushbutton pad to scroll through the objects assigned to the current Scan List. The ► and ◀ keys on the 5-way pushbutton pad are used to browse up and down through the Scan Lists, respectively. Only Scan Lists that contain objects are shown when browsing. A quick low-high wrap beep is played when the scanner reaches the last occupied Scan List and wraps back to the beginning.

When the scanner is stopped on a TGRP while scanning, or paused in Manual Mode, the display will appear as follows:

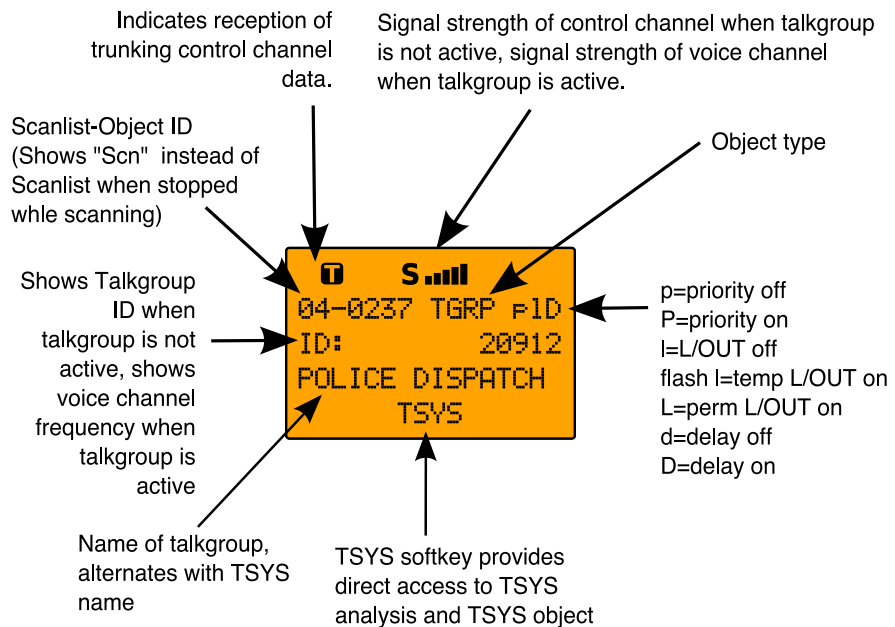

When the scanner is stopped on a conventional channel while scanning, or while paused in Manual Mode, the display will appear as follows:

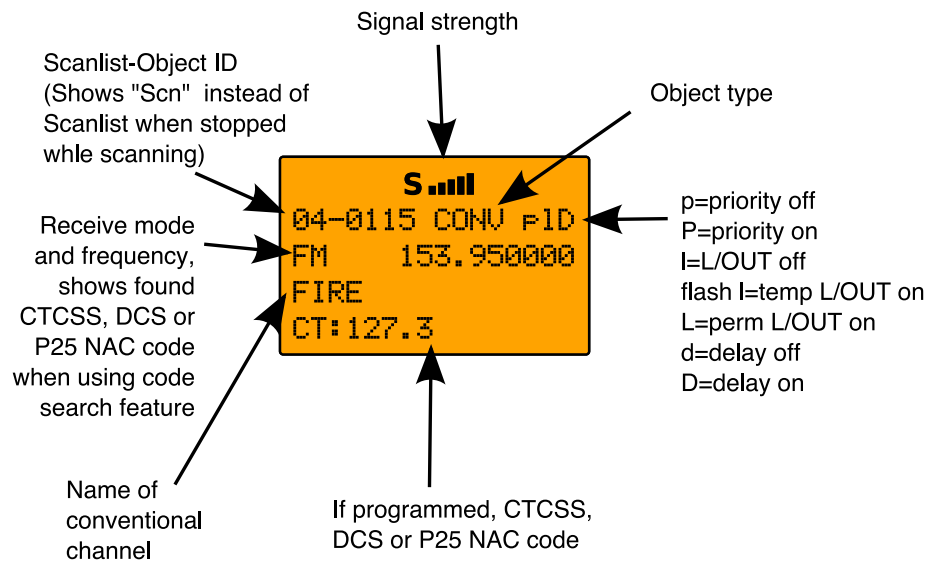

## Browsing Objects

The 5-way pushbutton pad makes it easy for you to browse the stored objects in your PSR-500 when in Manual or Program modes. Press MAN or PGM, then use the ◀ ▶ ▲ ▼ keys on the 5-way pushbutton pad to move around in the scanner's memory as follows:

- ▲ : navigates "up" through the objects assigned to the current Scan List
- ▼ : navigates "down" through the objects assigned to the current Scan List
- ◀ : navigates "up" through the active Scan Lists in the radio
- ▶ : navigates "down" through the active Scan Lists in the radio

## Advanced Startup Topics

Congratulations! Now that you have mastered the creation of Scannable Objects and how to monitor them using Scan and Manual Mode, you can move on to some more advanced startup topics.

This Advanced Startup Topics section of this manual will provide you with more basic information about how you can create other types of Scannable Objects, and how you can group your

Scannable Objects into different Scan Lists and work with the Scan Lists to quickly enable or disable groups of objects that you want to monitor. You can also read the Detailed Menu Reference section of this manual to learn more about the different object types and their parameters, and how to perform more advanced operations with your scanner.

## About Object Numbering

Your PSR-500 is different from other types of scanners in how it stores your Scannable Objects in memory. Instead of fixed channels and banks, objects are stored in the first available block of free memory and assigned an Object ID. The Object ID is the “address” where the object is stored in memory.

The Object ID is displayed as a four digit number in the upper left-hand corner of the display whenever an object is selected in Manual Mode and PGM modes, and when the scanner stops on an active object while scanning. Additionally, the current Scan List number is displayed prior to the Object ID when an object is selected in Manual Mode or PGM mode, i.e.,

10-0348

indicates Object ID 0348 mapped to Scan List 10.

### *Using the Object ID to directly access an object*

You can use this address to quickly access your stored objects when in the Manual Mode and PGM modes. Press MAN or PGM, then key the Object ID using the numeric keypad, then press ENT to go to that object. In the above example, press MAN or PGM, then key 0348 ENT to jump directly to that object.

Note that objects are not really “in” a Scan List, or Scan Lists. Objects are “mapped” to Scan Lists, meaning that an object can be a member of one or more Scan Lists. In the above example, 10-348 means that the object itself is stored in memory address 0348, and is mapped to (at a minimum) Scan List 10, and, if you were to use the ▲ ▼ keys to scroll up or down while viewing Scan List 10, you will see all the other objects that are also mapped to Scan List 10.

## More About Wildcard Scanning

As mentioned previously, a Wildcard TGRP object allows you to receive all radio traffic on a trunked radio system.

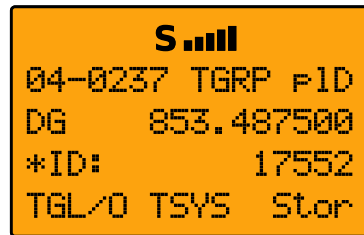

A Wildcard TGRP works by catching talkgroup calls on the system that are not already stored as objects in the radio's memory.

In order for the Wildcard TGRP to function properly, the radio needs to be in SCAN mode. This is what enables the scanner to find the previously stored TGRP objects that need to be checked before declaring that the found talkgroup is new and should be scanned as a Wildcard "hit".

If you park on a Wildcard TGRP object in MAN mode, the scanner is not able to "see" the previously stored TGRP objects, and every call on the trunked radio system will come up as a wildcard hit.

## Displaying Memory Usage

Your scanner can report how much free memory is available for new objects, and show how much memory has been used, and how the memory is allocated to different types of objects. To display the memory usage report, use the power-on shortcut by pressing 0, then 0 again while the Welcome/Owner screen is displayed just after the radio is powered on, or, press PGM, then the GLOB softkey to access the Global configuration menu, then scroll down using the ▼ key until Memory Info:SEL appears in the display. Press SEL to view the memory usage report. Use the ▲ ▼ keys to scroll the display.

## Search Object Types

A very powerful feature of your PSR-500 is the ability to define different types of frequency searches and process them while scanning. Frequency searches are just another type of Scannable Object in the hierarchy of the radio's memory organization, so they can be manipulated and scanned in the same manner as conventional channels and trunking talkgroups.

There are several different types of frequency searches available in your scanner.



## **Limit Search Object (LMIT)**

A Limit Search Object (LMIT) is a search object that stores the parameters necessary for the radio to search each frequency within a lower and an upper limit for activity. A LMIT object can be used for standalone searching – the radio just searches and stops when activity is detected on a frequency, or for searching that is performed while the radio is scanning. The radio treats LMIT objects just like any other Scannable Object when in Scan Mode. If you create a LMIT object, assign it to a Scan List and press the **SCAN** key, the radio will check for activity on all the Scannable Objects – TGRP objects, CONV objects, and even LMIT objects. An example of when this might be handy would be when you want to scan for activity on a collection of TGRP and CONV objects, then run through a range of frequencies to look for activity there, such as the entire 2 meter amateur radio band or the entire VHF marine radio band. When used in Scan Mode, this capability is best suited for small ranges of frequencies that contain more frequencies than practical to program as individual channels. Any size range can be used, but larger ranges that take more time to search will increase the chances of missed activity on other object types.

### Essential Limit Search parameters

Much like the other object types, there are only a few parameters that are essential in order for a search range to function correctly. The **FrLo** and **FrHi** lower and upper frequency limits must be specified, so the scanner will know where to begin the search, and where to end the search and start again. The **Mode** must be set properly, although by default the scanner will automatically choose the receive mode that most likely applies to the active frequency as the search proceeds. And again, we recommend that you give the LMIT object a name in the **Tas** field so that you can easily find or identify it later.

To create a new LMIT object, press **PGM** to place your scanner into Program Mode, then press the **NEW** softkey, then press the **SRCH** softkey to view the available Search types, then press the **LMIT** softkey. Use the data entry methods you have already learned for CONV and TGRP object setup to specify the **FrLo** and **FrHi** limits, and provide a name for your search in the **Tas** field. When finished, press the **Save** softkey to store your LMIT search as a new object.

Once your LMIT object is saved, you can use it while scanning, or launch the LMIT search by itself by pressing the **SRCH** softkey (note that we are referring to the **SRCH** softkey, and not the **SRCH**

key on the keypad) after navigating to the LMIT object in Manual Mode.

When the LMIT search stops on an active frequency, the display will appear as follows:

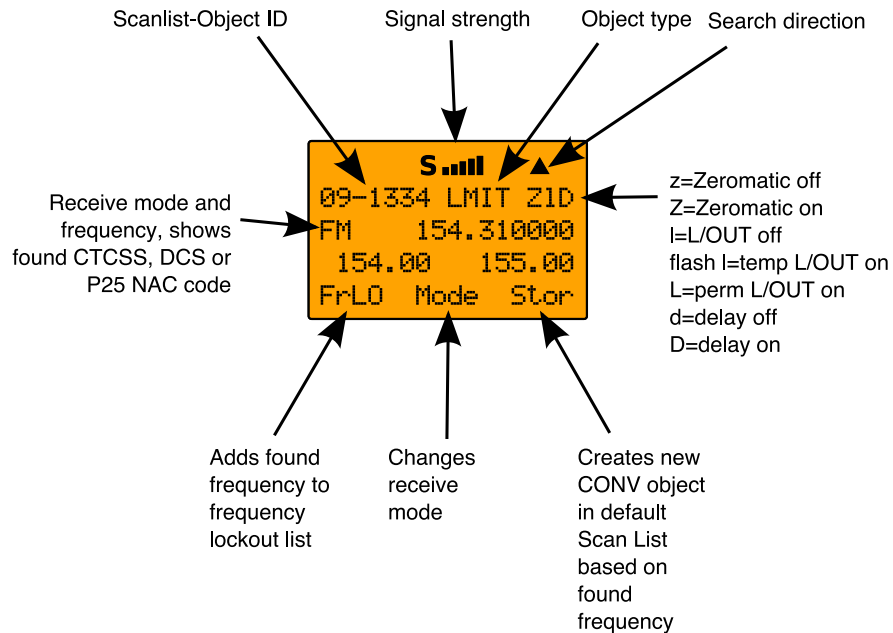

Press the PSE key to hold on the active frequency. To resume, press the PSE key again.



*HINT: It can take some time for the PSR-500 to process all of the frequencies in a LMIT search. You can experiment with different size frequency ranges to find a LMIT search setup that does not interfere excessively with scanning of other object types.*

### **Spectrum Sweeper Object (SWPR)**

A Spectrum Sweeper Object (SWPR) is a record that stores the parameters necessary for the radio to rapidly sweep a range of frequencies for strong signals from nearby transmitters. A SWPR object can be used for standalone operation – the radio just sweeps and stops when activity is detected, or for sweeping that is performed while the radio is scanning. The radio treats SWPR objects just like any other Scannable Object when in Scan Mode. If you create a SWPR object, assign it to a Scan List and press the SCAN key, the radio will check for activity on all the enabled Scannable Objects – TGRP objects, CONV objects, LMIT objects

and SWPR objects. An example of when this might be handy would be when you want to scan for activity on a collection of TGRP and CONV objects, then do a quick sweep for transmissions from nearby transmitters.

### Essential Spectrum Sweeper parameters

Like every other object type, there are certain parameters in a SWPR record that are essential in order for the SWPR object to function correctly. By default, a newly created SWPR object is ready to go without any changes. In its default configuration, the SWPR object will sweep through all of the important land mobile radio bands and look for strong signal activity from nearby transmitters. As you become more familiar with SWPR operation, you may wish to include or exclude some bands in your sweeps to check other frequency ranges or to limit the amount of time the scanner spends sweeping frequency ranges where local transmitter activity is less likely. This will speed up operation, and when used while scanning, will allow the radio to return to scanning for activity on CONV, TGRP and other enabled objects.

To create a new SWPR object, press PGM to place your scanner into Program Mode, then press the **NEW** softkey, then press the **SRCH** softkey to view the available Search types, then press the **SWPR** softkey. By default the SWPR parameters are set for a general purpose sweep of all important land mobile radio bands. Optionally, you may wish to toggle the **TYPE** field from All Bands to Public Safety by pressing **▶** on the 5-way pushbutton pad. When Public Safety is selected, the frequency sweep will be limited to those frequency ranges typically used for Public Safety communications. Note that other radio services also use these ranges, so don't be surprised if you occasionally hear activity that is not Public Safety related. The sub-bands are defined as follows:

0: 25-54 MHz	VHF Low Band
1: 108-137 MHz	VHF Aircraft Band
2: 137-174 MHz	VHF High Band
3: 216-300 MHz	220 MHz Commercial/Amateur Band
4: 300-406 MHz	UHF Military Air Band
5: 406-470 MHz	UHF Band
6: 470-512 MHz	UHF-T Band
7: 764-806 MHz	700 MHz Band
8: 806-869 MHz	800 MHz Band
9: 896-1300 MHz	900 MHz Band, 23 cm Amateur Band

In Public Safety, the sub bands are defined as follows:

- 0: 33.4-46.5 MHz VHF Low Band
- 1: 151-170 MHz VHF High Band
- 2: 453-467 MHz UHF Band
- 3: 764-806 MHz 700 MHz Band
- 4: 851-869 MHz 800 MHz Band

Sub bands can be selected and deselected by using the ◀ ▶ keys to scroll through the sub bands, and pressing the SEL key to toggle the selected sub band on or off. An asterisk character (\*) indicates that the sub band is enabled.

Be sure to provide a name for your SWPR object in the **Tag** field. When finished, press the **Save** softkey to store your SWPR search as a new object.

Once your SWPR object is saved, you can use it while scanning, or launch the Spectrum Sweeper object by itself by pressing the **SWPR** softkey after navigating to the SWPR object in Manual Mode.

When the SWPR object stops on an active frequency, the display will appear as follows:

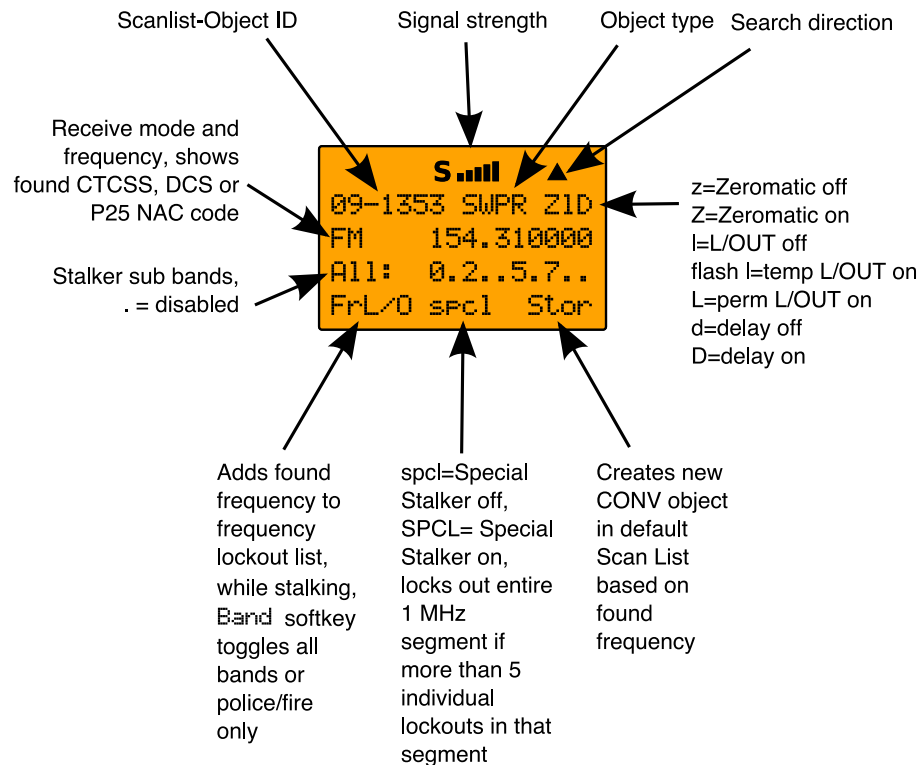

## **Service Search Object (SRVC)**

A Service Search Object (SRVC) is similar to a LMIT search but is optimized for a specific radio service, and can search for activity associated with a type of service across multiple frequency bands.

### Essential Service Search parameters

The only critical parameter needed for a Service Search to function is the service type. When you set up a Service Search, you will want to specify the type of service that you wish to search.

To create a new SRVC object, press PGM to place your scanner into Program Mode, then press the **NEW** softkey, then press the **SRCH** softkey to view the available Search types, then press the **SRVC** softkey. Scroll to the **Srvc:** field and select the type of search you want to define using the **◀ ▶** keys on the 5-way pushbutton pad. Service types include Public Safety, Aircraft, Amateur, CB, Marine, FRS/GMRS/MURS/DOT and Railroad, and provide frequency coverage as follows:

**Public Safety** (PubSafety) - Searches commonly used public safety frequencies. Groups are as follows:

- |    |               |               |
|----|---------------|---------------|
| 0: | 33.4-46.5 MHz | VHF Low Band  |
| 1: | 151-170 MHz   | VHF High Band |
| 2: | 453-467 MHz   | UHF Band      |
| 3: | 764-806 MHz   | 700 MHz Band  |
| 4: | 851-869 MHz   | 800 MHz Band  |

**Aircraft** - Searches civilian and military air frequencies. Groups are as follows:

- |    |             |                                      |
|----|-------------|--------------------------------------|
| 0: | 108-118 MHz | Navigation                           |
| 1: | 118-137 MHz | Civilian Voice                       |
| 2: | 138-150 MHz | Military Voice (excludes 2m Amateur) |
| 3: | 225-400 MHz | Military Voice                       |

**Ham** - Searches amateur radio frequencies. Groups are as follows:

- |    |               |             |
|----|---------------|-------------|
| 0: | 28.0-29.7 MHz | 10m Band    |
| 1: | 50-54 MHz     | 6m Band     |
| 2: | 144-148 MHz   | 2m Band     |
| 3: | 222-225 MHz   | 1.25cm Band |
| 4: | 420-450 MHz   | 70cm Band   |

5: 902-928 MHz 33cm Band  
 6: 1240-1300 MHz 23cm Band

**CB** - Searches the Citizens Band radio frequencies

**Marine** - Searches the VHF-FM marine radio band

**FRS/GMRS/MURS/DOT/STAR (F/G/MURS)** - Searches the FRS, GMRS, MURS, DOT and STAR radio frequencies

**Railroad** - searches the Association of American Railroads (AAR) VHF railroad frequencies used in the US and Canada

When finished, press the **Save** softkey to store your SRVC search as a new object.

Once your SRVC object is saved, you can use it while scanning, or launch the SRVC search by itself by pressing the **SRCH** softkey after navigating to the SRVC object in Manual Mode.

When the SRVC search stops on an active frequency, the display will appear as follows:

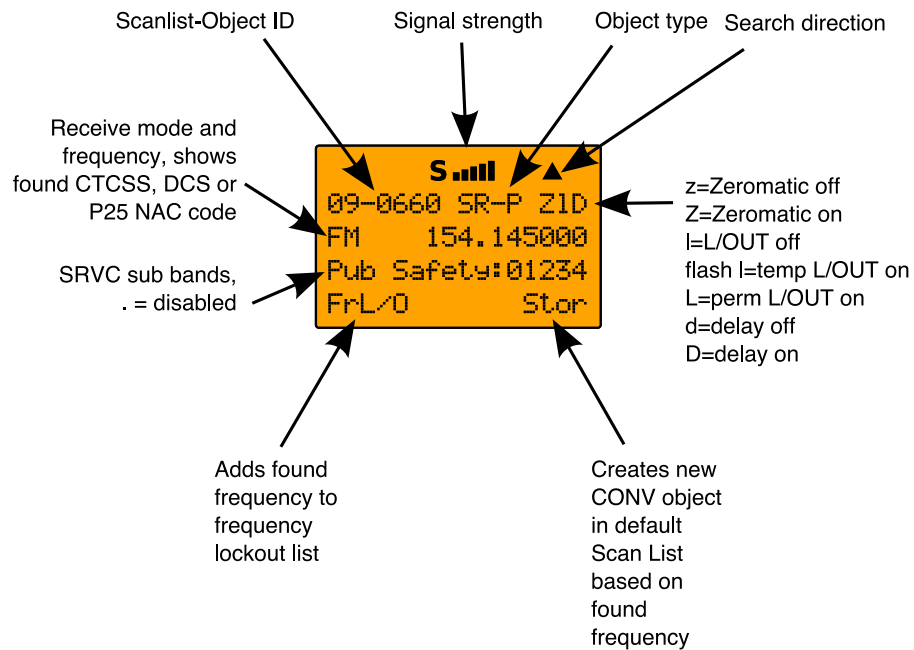

To resume searching, press the **▲** key.

Now, take a few moments to practice setting up each of the different search object types by experimenting and creating some SRVC, LMIT and SWPR objects.



*HINT: Remember that there is context sensitive help available for each menu item in the object menus. Just press **FUNC**, then **SEL** to view the help, and **SEL** again to exit the help screen.*

These are just a few of the many ways you can incorporate different types of search objects in your Scan List configurations. and, just a few of the many ways that each of the individual search types can be configured to your preferences and needs. Be sure to refer to the Detailed Menu Reference section of the manual for detailed information for each of the search object types.

## **Grouping Objects with Scan Lists**

By default, new objects are automatically assigned to Scan List 01. Now that you have entered a variety of new objects that are, by default, members of Scan List 01, you may want to separate these objects into separate Scan Lists so that you can easily enable or disable groups of objects as needed depending on what you want to scan. There are 20 regular Scan Lists available, a special “FAV” Scan List for one-button access to your favorite Scannable Objects, and a Skywarn Scan List.

Although Scan Lists may seem similar to the “banks” that are used in older bank/channel scanner designs, you will find that they are much more powerful and flexible than “banks”. The number of objects that can be grouped in a Scan List is limited only by the scanner’s memory, and single objects can be members of multiple Scan Lists without creating duplicate versions of those objects and manually placing them in each Scan List where you want them included.

You can also mix and match different object types in Scan Lists as you see fit. Feel free to group your objects in the manner that best suits your listening style. If you choose to group your objects by geographical area, and find that the best set of Scannable Objects for your area includes a mix of trunked talkgroups and conventional channels, go right ahead and put them all in the same Scan List. There are no limitations as to the type of objects that can exist together in the same Scan List.

How you group objects in Scan Lists is entirely up to you! Here are some examples of how objects can be grouped:

### ***Geographically***

You may wish to group your Scannable Objects according to the areas where they are used. For example, assume that you

routinely travel to another town to visit family. You can assign the channels and talkgroups for fire and police services around your home to one Scan List, and those that are located where your family lives in another. When you travel to visit your family, you can no longer hear the Scannable Objects assigned to your home Scan List, so you disable that Scan List and enable the Scan List that contains the channels and talkgroups that are in use in your family's town.

### ***By trunking system***

It is possible to assign any combination of object types to any Scan List. However, you may wish to assign TGRP objects associated with specific trunked radio systems to specific Scan Lists, so you can easily enable or disable monitoring of each system by enabling or disabling the associated Scan List.

### ***By object type***

It may be desirable to segregate object types by assigning them to specific Scan Lists. For example, you can assign a group of LMIT or SRVC searches to a single Scan List, and easily activate or deactivate searching on those objects by enabling or disabling the associated Scan List. You may wish to place your wildcard TGRP group call or private call objects in a separate Scan List.

### ***By application***

You can group objects by their application. For example, you may wish to place all law enforcement related objects for your area in one Scan List, all fire and rescue objects in another, and all business related objects in yet another Scan List. Racing fans may wish to group objects for different cars, drivers, teams and tracks into separate Scan Lists.

### ***By Favorites***

The Favorites (FAV) Scan List is a powerful tool that can be used to quickly narrow (or expand) your scanning profile.

In addition to the normal Scan List map, each Scannable Object menu includes a FAV (yes/no) item. When FAV is set to YES, the object is a member of the Favorites Scan List in addition to the other Scan Lists that it is mapped to in the normal Scan List map.

When you press the FAV key, the radio suspends scanning of all objects in the radio except for those that are set to FAV=YES in their object menus.



You can also add any object to the FAV Scan List by pressing the FUNC key, then FAV while the object is active during SCAN mode, or while parked on the object in MAN and PROGRAM mode.

It is also possible to clear the FAV Scan List completely by pressing PGM, then the GLOBE softkey, then scrolling to down to the Clear FAV menu item. Press the SEL key to set FAV=NO for all objects, press the YES softkey to confirm the action, then press the Save softkey to save your changes.

For example, you may wish to leave the FAV Scan List empty, and add your favorites while scanning by pressing FUNC, then FAV when objects of interest are active. This can be useful during a major event, where you wish to quickly isolate objects of interest by pressing FUNC FAV when they are active, then pressing FAV to scan only those objects.

The Favorites Scan List is also useful to group objects that are very close to where you live, so that when you press the FAV key, you are only scanning objects that are in your immediate vicinity, making the radio less active and increasing the chances that you will not miss important local activity.

Use your imagination and you will probably come up with many other ways to use the Favorites Scan List feature.

### ***Mapping Objects to Scan Lists***

By default, every new object you create is mapped to be a member of Scan List 01. Scan List membership is defined in an object's parameters menu and is typically found at the beginning of the menu.

To change Scan List membership when creating a new object, scroll up or down to the Scan Lists: parameter in the object's menu before saving the object. With the Scan Lists: field highlighted (as indicated by the blinking cursor), use the ◀ ▶ keys on the 5-way pushbutton pad to scroll through the Scan Lists until you find the Scan List that you wish to enable or disable membership for the object, and use the SEL button to toggle membership for that Scan List on or off. The asterisk (\*) next to the Scan List number indicates that the object is a member of that Scan List. Press the Save softkey to save the modified object. Objects can be members of as many Scan Lists as you see fit, without limitation to the number of Scan Lists an

object is mapped to, and without limitation to the number of objects that are mapped to a given Scan List.

To change Scan List membership for an existing object, press the PGM key. Use the ◀ ▶ ▲ ▼ keys on the 5-way pushbutton pad to scroll to the existing object that you wish to change, then press the EDIT softkey. Press the CURR softkey to edit the current object.



*NOTE: Remember, when browsing objects in Manual or Program Mode, the arrow keys on the 5-way pushbutton pad operate as follows:*

▲ : navigates “up” through the objects assigned to the current Scan List

▼ : navigates “down” through the objects assigned to the current Scan List

◀ : navigates “up” through the active Scan Lists in the radio

▶ : navigates “down” through the active Scan Lists in the radio

Scroll down in the object’s parameters menu to the Scan Lists: field. With the Scan Lists: field highlighted, use the ▶ on the 5-way pushbutton pad to scroll through the Scan Lists, and use the SEL button to toggle membership for a Scan List on or off. The asterisk (\*) next to the Scan List number indicates that the object is a member of that Scan List. Press the Save softkey to save the modified object.

### ***Naming, enabling and disabling Scan Lists***

By default, Scan Lists are named “Scan List 01 - Scan List 20”. If desired, you can give your Scan Lists names to describe their function. Press PGM, then press the GLOB softkey and scroll down to the Scan Lists parameter. Press the SEL key to display the Scan Lists sub menu. Scroll to the desired Scan List and press the ▶ key to edit the settings for the selected Scan List, Scroll to the Tag field and press the ▶ key to edit the name. Press the Done softkey when finished, then press the Save softkey to save the changes to the Scan List sub menu, then press the Save softkey again to save the changes to the Global menu. Scan Lists may be enabled or disabled while actively scanning, or by accessing the individual Scan List in the Global Settings (GLOB) menu.

To toggle a Scan List's enabled/disabled status while scanning, press the numeric key that corresponds with the Scan List you wish to toggle. For example, pressing 4 while scanning will toggle the state of Scan List 04 from enabled to disabled, or vice versa if the Scan List is already disabled. To toggle the enabled/disabled status for Scan Lists 11-20, press **FUNC**, then press a number key, i.e., press **FUNC 3** to toggle the status of Scan List 13. If you enable a Scan List that has no assigned objects, the number for that Scan List will flash in the display while the scanner is scanning.

When you enable a Scan List, the display briefly shows the name of the Scan List on Line 4 of the display, and the word **ON** or **OFF** at the end of Line 3 to indicate if the Scan List was toggled on (enabled) or off (disabled).

When Scan Lists 1, 2, 3 and 16 are enabled, the display will appear as follows while scanning:

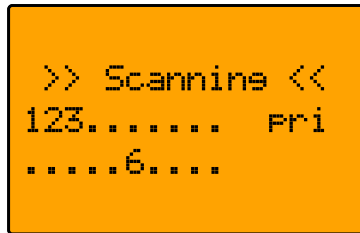

To toggle a Scan List's status from the Global Settings menu, press **PGM** to enter Program Mode, then press the **GLOB** softkey. At the **Scan Lists:** item, press the **SEL** key on the 5-way pushbutton pad. Scroll to the Scan List you wish to change and press the **SEL** key again, then at the **Enabled:** setting press the **◀** or **▶** on the 5-way pushbutton pad to toggle the Scan List on or off. An asterisk (\*) indicates that the Scan List is enabled. Press the **SAVE** softkey to save settings for that Scan List, then press **SAVE** again to confirm your global changes and exit the **GLOB** menu.

If you inadvertently store an object with no Scan List mappings, the object will be placed in a special "NS" Scan List that can be accessed using the **◀ ▶** keys while in Manual Mode or PGM mode. Once you scroll to the NS Scan List, you can use the **▲ ▼** keys to scroll to the objects found there and edit the Scan List setting by pressing the **PGM** key, then the **EDIT** and **CURR** softkeys to see the object's menu.

## Other Advanced Startup Topics

Here are some more startup topics that will help you get more enjoyment out of your PSR-500 as you become more experienced with its operation. We also suggest that you visit RadioReference at [www.radioreference.com](http://www.radioreference.com), where you can discuss the PSR-500 with other owners!

### ***Finding Stored Objects Easily***

The PSR-500's browse feature makes it easy to scroll to the Scan Lists and Scannable Objects you have created, using the ◀ ▶ ▲ ▼ keys on the 5-way pushbutton pad while the scanner is in PGM or Manual Mode. Here are some more methods you can use to find stored objects quickly.

### Searching For Objects Using FIND

Your PSR-600 provides a very useful FIND feature that allows you to search for locked out objects, or for objects that contain a text string that you specify. In text searches, FIND searches for your specified text in the following places:

- In TGRP objects, the ID field and the Tag field
- In CONV objects, the Frequency field and the Tag field
- In TSYS, LMIT, SRVC and SWPR objects, the Tag field

To use FIND, press the PGM key, then press the EDIT softkey. Press the FIND softkey.

To find objects that are locked out, press the L/Out softkey. The scanner finds the first locked out object. Press the L/OUT key to toggle lockout status. Press the EXIT softkey when finished. Press the EDIT softkey to edit the object menu for the found object. Press the NEXT softkey to find the next locked out object. When the scanner finds a matching object, you may press MAN to begin monitoring of the found object in Manual mode. You may also press PGM to exit FIND and execute programming tasks at the found object position. If you wish to edit the object, press the EDIT softkey. If you wish to continue searching, press the NEXT softkey.

To find objects that contain a specified text string, press the Text softkey then enter the text string you wish to search for. Press the OK softkey to begin searching. Press the Exit softkey to cancel the FIND operation. Press the Q.t.x.t softkey to use QuickText in your find text screen. For more information on text entry and QuickText, please see the section of this manual entitled "Standard Text Entry Method and QuickText". Once you

have started searching, the radio will stop on any object where your find text is found in the frequency, tag, or ID fields as described above. When the scanner finds a matching object, you may press **MAN** to begin monitoring of the found object in Manual mode. You may also press **PGM** to exit **FIND** and execute programming tasks at the found object position. If you wish to edit the object, press the **EDIT** softkey. If you wish to continue searching, press the **NEXT** softkey.

**FIND** keeps the last search text you specified stored so that you may use it again in subsequent **FIND** operations.

### Filtering By Object Type

When browsing objects in **PGM** mode, you can filter the objects that are displayed by their type.

Press the **PGM** key on the keypad, then press the **EDIT** softkey. Press the **◀** or **▶** keys on the 5-way pushbutton pad to scroll the Edit softkeys to display the filter softkeys. The filter softkeys are as follows:

```
CONV  
TGRP  
TSYS  
SRCH  
SWPR
```

To filter browse for a specific type of object, press the softkey that corresponds with that object type. For example, press the **CONV** softkey, then use the **◀ ▶ ▲ ▼** keys on the 5-way pushbutton pad to browse only conventional objects.

### **Object Lockout**

The **L/OUT** key is used to lock out objects. When an object is locked out, traffic is not received on that object until it is unlocked, even if the object is mapped to more than one Scan List. Locking out an object locks it out “radio-wide” until it is enabled by toggling the lockout setting.

Four types of lockout functions are available in the PSR-500, temporary lockout, permanent lockout, search lockout and talkgroup lockout.

### Temporary Lockout

Temporary lockout locks out an object until the scanner is turned off. When the scanner is powered on again, all objects that have been temporarily locked out are restored.

By default, the L/OUT key activates temporary lockout when pressed. If desired, you can change the function of the L/OUT key in the GLOB radio wide settings by pressing PGM, then the GLOB softkey. Scroll to the TLO=FUNC L/O setting and press the ▶ key to toggle the setting to YES to have the L/OUT key function as a permanent lockout instead of temporary lockout.

To apply temporary lockout to an object, press the L/OUT key while the scanner is stopped on that object during scan operation, or navigate to an object using the 5-way pushbutton pad while in Manual Mode or PGM mode and press the L/OUT key. The lowercase "l" in the display flashes to indicate that temporary lockout is applied to the object:

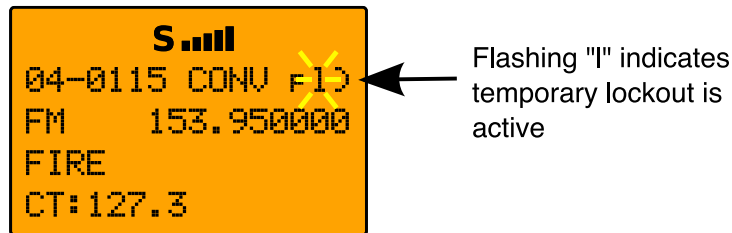

If you wish to remove temporary lockout from a single object, navigate to the object using the 5-way pushbutton pad while in Manual Mode or PGM mode and press the L/OUT key again.

Temporary lockout is a very useful feature. For example, when a major incident occurs while you are scanning, you may wish to focus your scanning on that major incident, and exclude unrelated talkgroups so that radio traffic associated with the major incident is not interrupted.

You could press the PSE or MAN keys to listen to a single object, if communications for the major incident are only being conducted on single channel or talkgroup. More often, several talkgroups are used to provide communications for major incidents, so if you park on a single object, you may miss communications on other objects that are related to the incident of interest.

By using Temporary Lockout, it is possible to “zoom in” on the objects that are carrying communications related to the incident of interest by pressing L/OUT every time an unrelated object becomes active. Eventually you will narrow down your monitoring

to those objects that are being used to provide communications for the incident you are trying to monitor.

### Permanent Lockout

Permanent lockout locks out an object until you explicitly unlock it. No traffic will be received on the locked out object while permanent lockout is active.

To apply permanent lockout to an object, press **FUNC**, then the **L/OUT** key while the scanner is stopped on that object during scan operation, or navigate to an object using the 5-way pushbutton pad while in Manual Mode or PGM mode and press **FUNC**, then the **L/OUT** key. The lowercase "l" in the display changes to uppercase to indicate that permanent lockout is applied to the object:

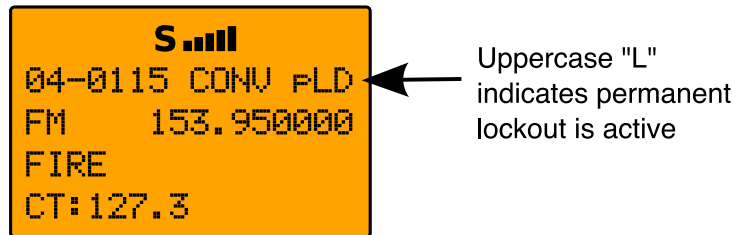

If you wish to remove permanent lockout from an object, navigate to the object using the 5-way pushbutton pad while in Manual Mode or PGM mode and press **FUNC**, then **L/OUT** again.



*HINT:* You can also toggle lockout anytime you are viewing an object menu in Program mode by pressing **L/OUT**.

### Search Lockout

Search lockout works with certain search objects, including LMIT searches, some SRVC searches, and SWPR objects. Frequency lockout is used to lock out undesired frequencies that are found during searches.

To apply search lockout during a search, press the **FrL/O** softkey while the scanner is stopped on the undesired frequency:

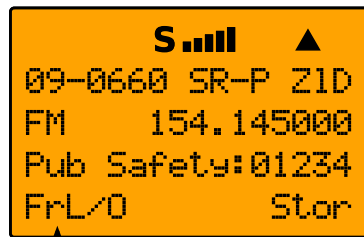

Press FrL/O  
to lock out an  
undesired  
frequency

Applying search lockout to an undesired frequency adds that frequency to the Search Lockout List, a list of frequencies that the scanner ignores when performing searches or during Spectrum Sweeper operations. You can edit or clear the Search Lockout List by following these steps:

Press PGM

Press the GLOB softkey

Scroll down to the SRCH L/Outs: item and press SEL

Scroll to the frequencies you wish to remove from the lockout list and press the Del softkey to remove them from the list.

Scroll to an empty spot and enter any frequency you wish to manually add to the list.

Press FUNC, then the Del softkey to clear the entire list.

### Talkgroup Lockout

Talkgroup lockout is similar to search lockout, as it allows you to lockout undesired talkgroups while searching for new talkgroup activity with wildcard TGRP objects.

To apply lockout on an undesired wildcard hit, press the TGL/O softkey while the scanner is stopped on the undesired talkgroup:



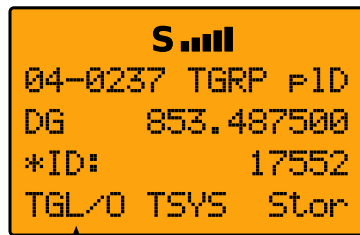

Press TGL/O to  
lockout an undesired  
wildcard talkgroup hit

Applying wildcard lockout to an undesired talkgroup creates a new TGRP object in the same Scan List as the wildcard TGRP, then applies permanent lockout to the new TGRP object, so that will be ignored in the future by the scanner when scanning the wildcard talkgroup. To unlock or edit talkgroups locked out using the wildcard lockout feature, press PGM, then navigate to the object using the 5-way pushbutton pad. Press FUNC, then L/OUT to remove permanent lockout from the talkgroup. Press FUNC, then CL to delete the TGRP object from the scanner. Press the EDIT, then the CURR softkey to edit and save the TGRP object.

### ***Setting the Default Scan List***

By default, your scanner will store all new objects, and objects found during Search, Tune, and Sweeper as mapped to Scan List 01.

You can easily change the default Scan List to any Scan List you specify, including the special FAV and SKYWARN Scan Lists.

Press PGM, then the GLOB softkey, and use the ▼ key to scroll down until the Dflt ScanList item appears in the middle of the display. Enter a new Scan List number to use as the default Scan List. The following numbers are valid:

0: The “not scanned” (ns) Scan List - objects that have no Scan List mappings can be found here

1-20: The twenty normal Scan Lists

21: The FAV Scan List

22: The SKYWARN Scan List.

Press ENT or the Done softkey to store your new default Scan List value, then press the SAVE softkey to save your changes to the radio's configuration memory.

### ***Deleting Objects***

Objects that you no longer need to use can easily be deleted from the PSR-500's memory, making room for new objects.

To delete an object, press PGM, then use the ◀ ▶ ▲ ▼ keys to navigate to the object you wish to delete. Press FUNC CL to delete the object. The scanner will ask you to confirm the delete command before removing the object from the scanner's memory. Deletions cannot be un-done.

To delete a TSYS, use the FIND feature to search for the TSYS by name. Press PGM, then press the EDIT softkey, then press the FIND softkey, and use the Standard Text Entry Method to enter all or part of the TSYS name you wish to delete. Press the OK softkey to begin searching, and, if necessary, press the NEXT softkey to continue searching until the desired TSYS is located. Once the TSYS has been located, press the PGM key, then press FUNC CL. The scanner will ask you to confirm the delete command before removing the object from the scanner's memory, then, provide a final warning that all TGRPs associated with the TSYS to be deleted will be lost if you proceed. Press the YES softkey at both warnings to delete the TSYS.

An alternative method is to browse TSYS objects only using the TSYS filter. Press PGM, then the EDIT softkey, then ▶ ▶ ▶, and press the TSYS softkey. Scroll to the desired TSYS using the ▲ ▼ keys, then press FUNC CL. The scanner will ask you to confirm the delete command before removing the object from the scanner's memory, then, provide a final warning that all TGRPs associated with the TSYS to be deleted will be lost if you proceed. Press the YES softkey at both warnings to delete the TSYS.

### ***Using Multi-Site Mode On Networked Systems***

Some Motorola and P25 systems include a large number of sites that are networked together to provide radio coverage to a large geographical area. These types of trunked radio systems are more commonly used for large statewide systems, and for some systems that are used in large, rural counties.

These networked trunked radio systems work in a manner that is very similar to a cellular telephone network. As a system user moves around (or “roams”) in the coverage area of the network, their radio will automatically find and use the nearest tower site. Each tower site includes a number of channels. One of these channels is used for control channel data, and the remaining channels are used for voice traffic. As a user moves away from the coverage of one site, their radio will search other control channel frequencies for a better site to use.

Your PSR-500 includes a Multi-site feature that can enhance the operation of the scanner when monitoring Multi-site systems. Multi-site can be enabled by editing the trunking system (TSYS) parameters for a Motorola or P25 system. Multi-site can be set to Off, Stat(Stationary) or Roam. By default, Multi-site is set to OFF.

The ROAM setting is ideal for those times when you are driving around in the service area of a networked trunked radio system, as it allows the radio to find and use the best tower sites as you move in and out of the coverage footprints of different sites. The STAT(ionary) setting is ideal for those times when you are not moving and are within range of more than one tower site, as it will allow you to monitor traffic from any tower that you are within range of.

To activate Multi-site mode on a Motorola or P25 networked system, follow these steps:

Press PGM, then navigate to a talkgroup on the networked multi-site system using the ◀ ▶ ▲ ▼ keys.

Press the EDIT softkey, then press the CURR softkey.

Scroll down to the TSYS item and press the SEL key to edit the TSYS parameters.

Scroll to Multi-Site. Use the ◀ ▶ keys to select Off, Stat, or Roam. When set to Off, the scanner will find the first usable control channel in the control channel list and use it until it is no longer usable. When set to Stat.(ionary), the scanner will track the system using any control channel in the list that is usable. When set to Roam, the scanner will attempt to locate and use the best possible control channel and ignore others, until the control channel is no longer usable, then it will locate a new “best control channel” to use. When Multi-Site=ROAM, the scanner will always attempt to lock on to control channels where the decoding quality is greater than the Threshold Hi setting, and will

search for new control channels when the decoding quality of a control channel drops below Threshold Lo setting, and, if no new control channels are available that meet the Threshold Hi criteria, the scanner will seek the best control channel to use, and continue checking periodically for a new control channel that meets the Threshold Hi criteria. When `Multi-Site=STAT`, the scanner will track the system using every usable control channel in the control channel list.

Press the `SAVE` softkey to save your changes to the `TSYS` parameters, then press the `SAVE` softkey again to use the scanner.

You should experiment with the different Multi-site modes and the threshold settings to find a combination that works best for your location. Keep in mind that the threshold settings are only available when `Multi-Site Roam` is selected.

Multi-site functionality is not available in EDACS or LTR trunking.



*NOTE: It may be necessary to change the values used for Threshold Hi and Threshold Low in the `TSYS` object to optimize Multi-site Roam performance.*

### **LTR Home Repeater AutoMove**

LTR Home Repeater AutoMove takes the guesswork out of programming LTR trunking systems when the home repeater order is not known.

By default, LTR Home Repeater AutoMove is turned off and is controlled in the individual `TSYS` objects. To enable LTR Home Repeater Automove, access the menu for the desired `TSYS`, then scroll down to the last item in the menu, `AutoMove HRs`. Use the `◀ ▶` keys to toggle AutoMove HRs on or off for the selected `TSYS`, then press the `Save` softkey to save your changes.

When AutoMove HRs is turned on, you may enter the LTR system frequencies in any order, and the PSR-500 will automatically move the frequencies to the proper home repeater slots as transmissions are received on the system.

### **Priority Scan**

Your PSR-500 scanner features Priority Scan operation for `CONV` and `TGRP` objects. When Priority Scan is active,

increased priority is given to objects that have their **Priority** mode set to **ON**.

#### Turning Object Priority On or Off

Priority for CONV and TGRP objects can be toggled on or off using the following methods:

Press the **PRI** key when the scanner stops on the object while it is active. The **PRID** indicator in the object display will show **P** for Object Priority Off, and **F** for Object Priority On.

Browse to an object in Manual Mode or PGM mode, then press the **PRI** key to toggle Object Priority on or off. The **PRID** indicator in the object display will show **P** for Object Priority Off, and **F** for Object Priority On.

Browse to an object in PGM mode. Press the **EDIT**, then **CURR** softkeys. Use the **▼** key to scroll to the **Priority** setting. Use the **◀** or **▶** keys to toggle **Priority On** or **Off**.

When creating a new object, before saving the object scroll to the **Priority** setting. Use the **◀** or **▶** keys to toggle **Priority On** or **Off**.

#### Turning Priority Scan Mode On or Off

While the radio is scanning, press **FUNC**, then **PRI** to toggle Priority Scan On or Off. Priority Scan status is shown in the man Scanning status display. **PRI** indicates that Priority Scan mode is on, and **Pr i** indicates that Priority Scan mode is off.

#### CONV Priority Scan

When Object Priority is set to Yes for one or more CONV objects, the scanner will sample the CONV objects for activity periodically while scanning and monitoring other objects.

This sampling will cause a brief muting of received audio when it occurs while another object is active.

The more CONV objects are set for Priority, the longer this audio muting will be, since it takes a certain amount of time to sample each Priority CONV object for activity.

#### TGRP Priority Scan

When Object Priority is set to Yes for one or more TGRP objects, the scanner will give those TGRPs priority over other TGRPs while checking a particular trunking system for activity. TGRPs

configured for Priority are checked for activity before any other TGRPs are checked, and during the reply delay time after non-priority TGRP calls.

Additionally, your PSR-500 decodes the subaudible priority data that is present on analog Motorola talkgroup calls (3600 baud control channel systems only), and will switch to a priority talkgroup when the data for that talkgroup is found in the subaudible priority data.

### ***Hit Counters***

Your PSR-500 includes a unique Hit Counter feature that keeps track of how many transmissions are received for each object type. The Hit Counter for an object is incremented each time a transmission is received on an object, making it possible for you to determine the objects that are the least and most active.

By default, the Hit Counter feature is turned off. To turn the Hit Counter on, press PGM, then the GLOB softkey, and use the ▼ key to scroll down to the Hit Counts item. Use the ◀ ▶ keys to toggle Hit Counts on and off. When finished, press the SAVE softkey to save your changes to the radio's configuration memory.

You can view the hit counts for an object by navigating to the object by pressing PGM, then using the ◀ ▶ ▲ ▼ keys to navigate to the desired object, if necessary. Once you have selected the desired object, press the EDIT softkey, then the CURR softkey, and scroll to the Hit Count item bottom of the object menu to view the hit counter.

To reset the hit counter for a single object, press the Dflt softkey while the Hit Count item is selected in the object's menu.

To clear all hit counters, press the PGM key, then the GLOB softkey. Use the ▼ key to scroll down to the Clear Hits item, then press the SEL key. Press the SAVE softkey to save your changes and exit the Global settings menu.

### ***Audible Alarms and the ALERT LED***

Your PSR-500 features a very powerful ALERT LED with Audible Alarm capability that allows you to set different types of visual and audible notifications for the different types of objects you create.

You may have noticed that the menus for each object you create include various settings for LED, Backlight and Alarm. You can use these settings to design custom visual and/or audible alarms that are triggered when activity is detected on the specified Scannable Object.



*NOTE: The Alert LED utilizes a special tri-color Light Emitting Diode module that mixes light from red, green and blue LED elements to produce thousands of different colors. Eight pre-defined color settings are available for use in object menus. LED COLOR: 0 is normally used for "all colors off", or no Alert LED display.*



*NOTE: Slight variations to LED colors are a normal part of the manufacturing process. You may notice these variations when using the White LED color setting ( LED COLOR: 0), or when comparing one PSR-600 to another. You can compensate for these slight variations by fine-tuning the Red/Green/Blue (RGB) LED settings for each color. See the COLOR settings in the GLOB menu in Detailed Menu Reference section at the end of this manual.*

## Audible Alarm and ALERT LED Settings

Each object you create has the following ALERT LED and Audible Alarm settings:

**LED Mode:** Solid or Flash controls whether the LED remains on solid or flashes when the object is active.

**LED Color:** 0-7 sets the color of the LED. By default, color 0 is used for LED off. You can change the LED colors in the Global Settings menu.

**Latch LED** keeps the LED on after activity on the object is finished. This is useful in cases where you need to know if an object was active while you were away from the scanner.

**Backlight:** Off, On, Flash controls whether the backlight remains off, comes on solid or flashes when the object is active.

**Alarm:** None, Chirp, Hi-Lo, Alert, Ring, 2-Chirp, Fast Hi-Lo, DTMF # are used to set audible alarms that play each time activity is found on the object.

## ALERT LED with Audible Alarm Examples

Here are some examples of when you may wish to use the ALERT LED with Audible Alarm capability:

- You have programmed a Talkgroup Wildcard in for a trunked radio system you monitor in order to find new talkgroups. You can use an Audible Alarm to alert you when the radio receives a wildcard hit, and turn on the backlight so that you can read the display and operate the keypad to save or lock out the new talkgroup.
- You have programmed your favorite amateur radio repeater in and wish to be alerted when a QSO begins. You can use an Audible Alarm with one of the shorter alarms (Chirp, 2-Chirp, Fast Hi-Lo or DTMF #) to provide this indication without covering the traffic in the QSO.
- You have included a Spectrum Sweeper object in your scan configuration so that you can find nearby strong transmitters while you are scanning. You can use an Audible Alarm to alert you when the radio receives a Spectrum Sweeper hit, and turn on the backlight so that you can read the display and operate the keypad to save or lock out the new frequency. This technique is also useful for TGRP wildcards.
- You wish to assign different LED colors to different types of public safety agencies, i.e., red for fire, rescue and EMS, blue for law enforcement, yellow for emergency management, and so on. When there is activity you can tell if it is related to law enforcement, fire/rescue and EMS or emergency management at a glance, even if the transmission is short or difficult to copy.

The possibilities for the ALERT LED with Audible Alarm capability are limited only by your imagination.

### ***Dedicated search modes***

In addition to its powerful ability to store different types of frequency searches as objects, your scanner provides fast access to dedicated frequency search modes that allow you to execute searches or run the Spectrum Sweeper without having to go through the process of setting up and saving a search object. This is handy for those times where you need to run a search quickly. Dedicated search modes do not create new search objects or use previously created search objects.

#### Using Dedicated Spectrum Sweeper (SWPR) Mode

Dedicated SWPR mode lets you access and run the Spectrum Sweeper easily and quickly. Press FUNC SCAN while in the Manual, Program or Scan Modes to access the Spectrum Sweeper dedicated mode.



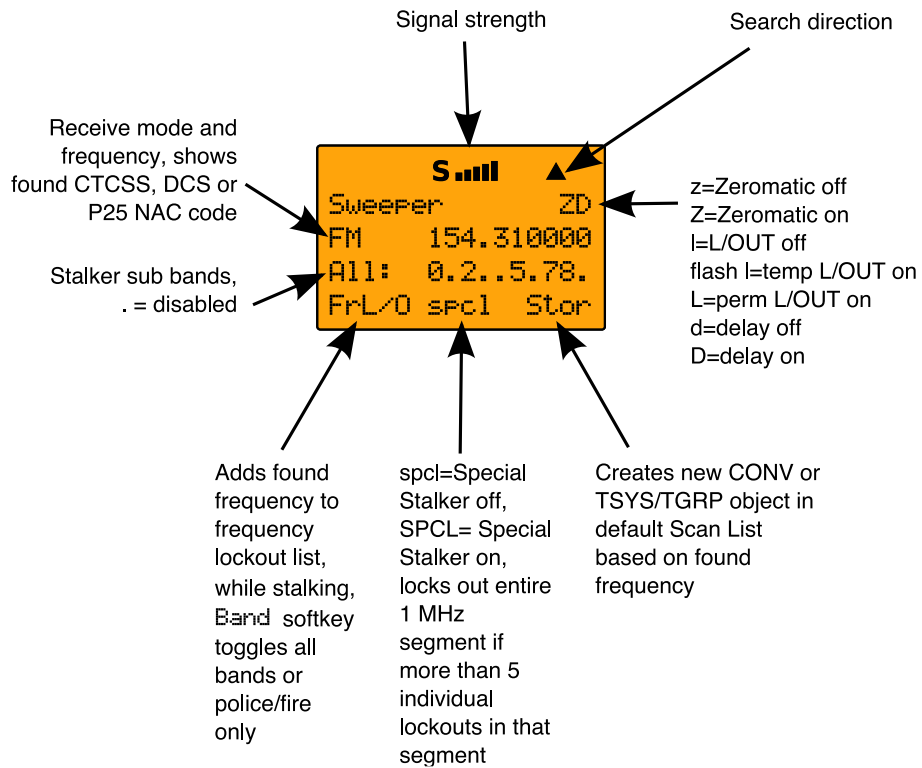

*NOTE: When a signal is being received, the Band softkey (F1) changes to FrL/O. You can access the Band softkey by pressing FUNC F1 when the F1 key function is FrL/O.*

Operation of the dedicated Spectrum Sweeper mode is almost identical to that of the object mode, with one exception. When running the Spectrum Sweeper as a Scannable Object, you must use the object menu to enable or disable the Spectrum Sweeper sub-bands when operating in Scan Mode. When dedicated Spectrum Sweeper mode is used, you may press the numeric key on the keypad that corresponds with the sub-band you wish to enable or disable. Disabling a sub-band will cause the Spectrum Sweeper system to skip the frequencies within that sub-band as it performs its sweeps. The sub-bands are defined as follows:

- 0: 25-54 MHz      VHF Low Band
- 1: 108-137 MHz      VHF Aircraft Band
- 2: 137-174 MHz      VHF High Band
- 3: 216-300 MHz      220 MHz Commercial/Amateur Band
- 4: 300-406 MHz      UHF Military Air Band
- 5: 406-470 MHz      UHF Band
- 6: 470-512 MHz      UHF-T Band

- 7: 764-806 MHz 700 MHz Band
- 8: 806-869 MHz 800 MHz Band
- 9: 896-1300 MHz 900 MHz Band, 23 cm Amateur Band

In Public Safety, the sub bands are defined as follows:

- 0: 33.4-46.5 MHz VHF Low Band
- 1: 151-170 MHz VHF High Band
- 2: 453-467 MHz UHF Band
- 3: 764-806 MHz 700 MHz Band
- 4: 851-869 MHz 800 MHz Band

### Using dedicated TUNE mode

Your scanner's dedicated TUNE mode provides you with the ability to quickly enter any frequency and monitor that frequency for transmissions, or search up or down from that frequency for activity.

To enter TUNE mode, press the TUNE key on the keypad. The scanner displays the TUNE screen.

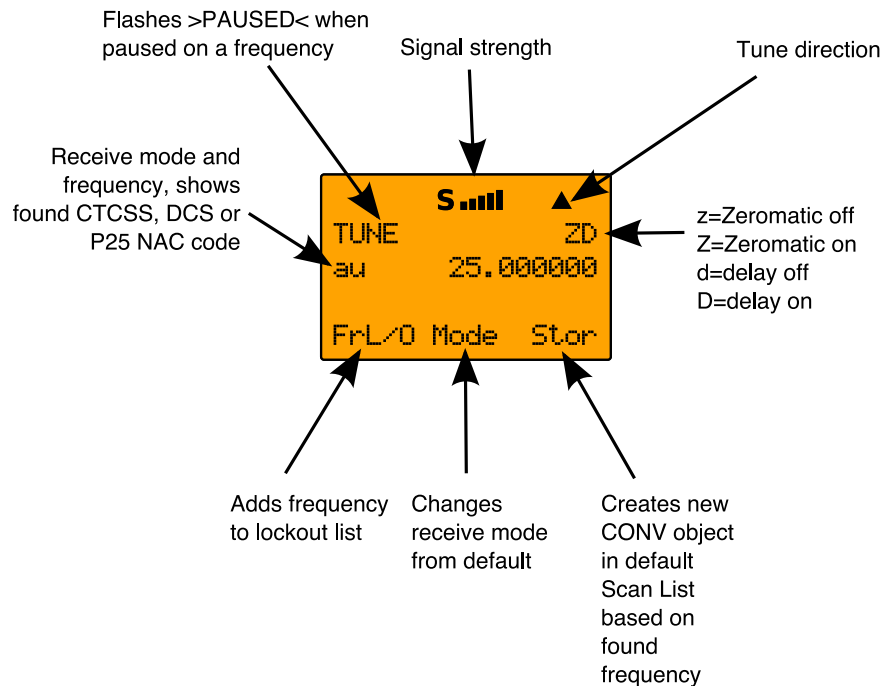

By default, TUNE mode is paused when first activated. Press PSE to begin searching from the current frequency.

Press the ▲ or ▼ keys on the 5-way pushbutton pad to change the search direction.

Press the **FrL/0** softkey to add a found frequency to the lockout list.

Press the **MODE** softkey to change the receive mode (AM, FM, NFM) from the default for the current frequency range (au).

Press **STOR** to create a new CONV object using the found frequency.

Use the keypad to enter a new frequency, and press **ENT** to make that the TUNE frequency.

Using **FUNC TUNE** from any other mode will load the last active frequency from the other mode into TUNE. For example, pressing **FUNC TUNE** while parked on a trunked radio TGRP will load the control channel frequency into the TUNE mode if the control channel frequency is the last frequency that the scanner checked while scanning.

Dedicated TUNE mode will always check for the presence of encoded squelch and digital modulation each time it finds an active frequency. If a valid encoded squelch code is found, it will be shown on the display, and stored automatically when you press **STOR** to create a new CONV object.

Dedicated TUNE mode also displays information about trunking control channels and trunked voice channels it finds while tuning through the RF spectrum. The following information is displayed for the various trunking modes:

Trunked Mode	Analysis Display
Motorola 3600 baud control channel	<pre>qq% SID:ssss St.t</pre> <p>where qq=decoding quality of the control channel data, SID=System ID, and S=Site Number</p>
P25 9600 BPS control channel	<pre>qq% Nnnn W:wwwww Sys:sss Rrr St.t</pre> <p>where qq=decoding quality of the control channel data, N=NAC, W=WACN, SYS=System ID, R=RFSS, and S=Site Number</p>

Trunked Mode	Analysis Display
EDACS control channel	<pre>qq% S:ss h/H s/S a/A</pre> <p>where qq=decoding quality of the control channel data, S=Site ID, h/H=not home site/is home site, s/S=not SCAT site/is SCAT site, a/A=not Aux CC/is Aux CC</p>
LTR home repeater	<pre>HR:hh A-HH-GGG</pre> <p>where HR=the home repeater number of the tuned frequency, A-HH-GGG=the Area, Home Repeater and Group ID of the LTR talkgroup</p>
Motorola analog voice channel	<pre>VC: lSTGID-nnnnn</pre> <p>where lSTGID shows the decoded talkgroup ID data from the lowspeed data stream</p> <p>Please note that the analog lowspeed data protocol does not provide error correction, and some false "VC: lSTGID" readings should be expected.</p>

You may wish to use the PSR-500's Tune LED feature to obtain a visual indication of signal strength using the tri-color LED. To activate the Tune LED, press PGM, then the GLOBE softkey. Press the ▼ key until Tune LED: Off appears in the display. Use the ◀ ▶ keys to toggle Tune LED on or off, then press the SAVE softkey to save your changes to the radio's configuration memory.

### Using dedicated Limit and Service search modes

The SRCH key provides immediate access to the dedicated search modes of your PSR-500. Pressing the SRCH key cycles through each search mode in this order: Limit, Railroad, Public Safety, Aircraft, Ham, CB, Marine, and FRS/GMRS/MURS/DOT.

### LMIT Search Mode

Your scanner's dedicated LMIT search mode provides you with the ability to create a limit search with a search frequency range between upper and lower limit frequencies that you specify and perform the limit search directly without creating a new LMIT object. You can then monitor that frequency range for transmissions.

To enter LMIT mode, press the SRCH key on the keypad repeatedly until the display indicates LMIT search as follows:

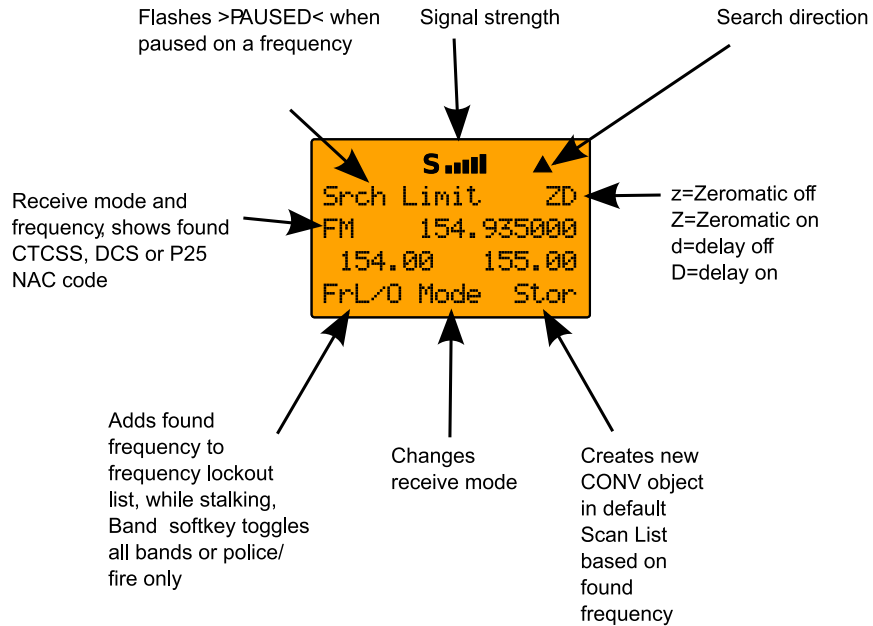

Use the **Lmts** softkey to set the lower and upper frequency limits for your limit search.



*NOTE: When a signal is being received, the Lmts softkey (F1) changes to FrL/O. You can access the Lmts softkey by pressing FUNC F1 when the F1 key function is FrL/O.*

Press the **▲** or **▼** keys on the 5-way pushbutton pad to change the search direction.

Press the **MODE** softkey to change the receive mode (AM, FM, NFM) from the default for the current frequency range (au).

Press the **FrL/O** softkey to add a found frequency to the lockout list.

Press the **STOR** softkey to create a new CONV object using the found frequency.

### Using dedicated SRVC mode

Your scanner's dedicated SRVC search modes provide you with the ability to instantly access each of the scanner's service search ranges without creating a new SRVC object.

To activate dedicated SRVC search mode, press the SRCH key on the keypad repeatedly until the desired service search is

indicated on the display. The following service searches are available:

**Railroad** - searches the Association of American Railroads (AAR) VHF railroad frequencies used in the US and Canada

**Public Safety** (PubSafety) - Searches commonly used public safety frequencies. Groups are as follows:

- 0: 33.4-46.5 MHz VHF Low Band
- 1: 151-170 MHz VHF High Band
- 2: 453-467 MHz UHF Band
- 3: 764-806 MHz 700 MHz Band
- 4: 851-869 MHz 800 MHz Band

**Aircraft** - Searches civilian and military air frequencies. Groups are as follows:

- 0: 108-118 MHz Navigation
- 1: 118-137 MHz Civilian Voice
- 2: 138-150 MHz Military Voice (excludes 2m Amateur)
- 3: 225-400 MHz Military Voice

**Ham** - Searches amateur radio frequencies. Groups are as follows:

- 0: 28.0-29.7 MHz 10m Band
- 1: 50-54 MHz 6m Band
- 2: 144-148 MHz 2m Band
- 3: 222-225 MHz 1.25cm Band
- 4: 420-450 MHz 70cm Band
- 5: 902-928 MHz 33cm Band
- 6: 1240-1300 MHz 23cm Band

**CB** - Searches the citizen's band radio frequencies

**Marine** - Searches the VHF-FM marine radio band

**FRS/GMRS/MURS/DOT/STAR** (F/G/MURS) - Searches the FRS, GMRS, MURS, DOT and STAR radio frequencies

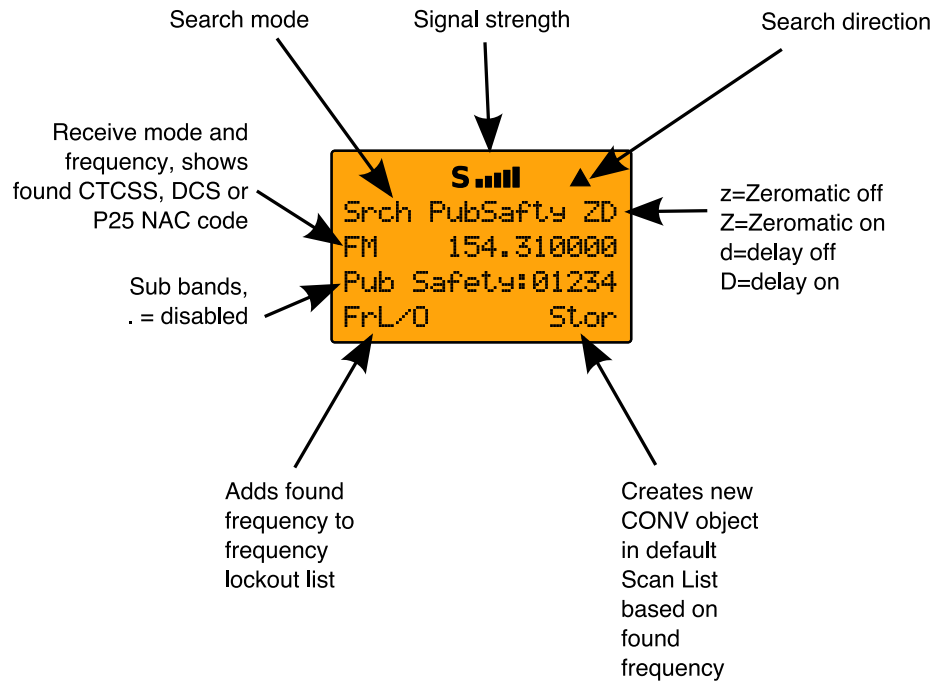

Use the numeric keypad to toggle the sub bands on and off while searching.

Press the ▲ or ▼ keys on the 5-way pushbutton pad to change the search direction.

Press the FrL/O softkey to add a found frequency to the lockout list.

Press the STOR softkey to create a new CONV object using the found frequency.

### Using Weather Modes

Your PSR-500 also functions as a powerful weather alert receiver. There are three modes of weather alert operation available to you.



**NOTE:** Your scanner incorporates weather alert as one of its features and is an extremely sensitive high quality receiver on the weather frequencies. However, the included flex antenna is optimized for general purpose scanning. If you use this scanner as your only means for receiving weather alerts, please check to be sure you are receiving a clear signal on the flex antenna or switch to an external antenna that gives you clear reception of a local NOAA weather broadcast.

## Weather Radio Mode

Weather radio mode allows you to receive weather broadcasts from your local weather service anytime of the day.

To use weather radio mode, simply press the WX button on the keypad. The scanner will quickly scan and lock on to the first active weather radio frequency it receives. You can use the ▲ or ▼ keys on the 5-way pushbutton pad to force the radio to look for other weather radio transmitters. It is generally best to select the weather radio transmitter that provides you with the strongest signal. You can use the signal meter to help you choose the best weather radio transmitter for your area. While operating in Weather Radio Mode, your scanner will alert on SAME messages that match the SAME location codes you have entered, or all SAME messages if you do not enter any SAME location codes.

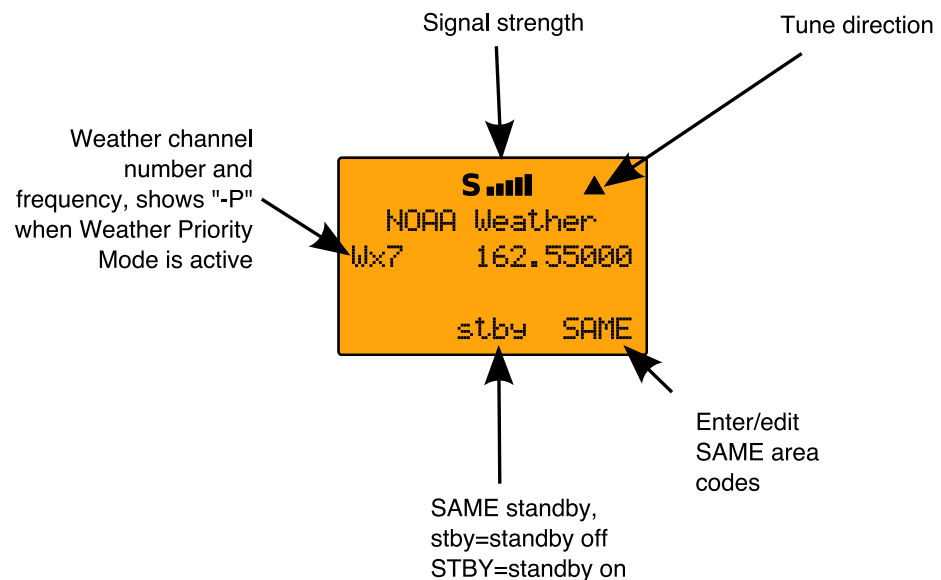

## Weather Priority Mode

Weather Priority mode samples the specified weather frequency periodically while scanning to see if the All Hazards 1050 Hz Warning Alert Tone (WAT) is present. If the WAT is present, the scanner will sound an alarm and tune to the specified weather frequency to monitor the nature of the alert.

To activate Weather Priority Mode, follow the steps above listed above in Weather Radio Mode to find the strongest weather radio transmitter for your area. Once the radio is tuned to the



strongest weather radio transmitter for your location, press the PRI key on the keypad. When in Scan Mode, the radio will check the specified weather frequency periodically for the 1050 Hz Warning Alert Tone (WAT). If WAT is found, the radio will sound an alarm and monitor the weather alert audio.

### SAME Standby Mode

SAME Standby Mode monitors the specified weather frequency silently, waiting to receive a Specific Area Message Encoding (SAME) alert that corresponds with a SAME location code that you have previously entered. If there is a match between a sent SAME location code and one that you have previously stored, the scanner will sound an alarm, display the alert type, and monitor the nature of the alert.

To activate SAME Standby Mode, first you should provide at least one SAME location code for your city, county or state. By default, SAME mode will alert on any SAME message received if no SAME location codes are entered. A list of SAME location codes can be found online at this web site:

<http://www.nws.noaa.gov/nwr/indexnw.htm#sametable>

In addition to the code for your location, you may wish to enter additional codes for surrounding areas and any other areas of interest so that you can receive advance warning of adverse or dangerous weather that may be headed in your direction.

Unlike other weather alert radios, your scanner features a powerful SAME wildcard feature that allows you to set the radio to alarm on partial matches of the location code. For example, the SAME location code for Dallas, TX is 048113, which can be broken down as follows:

0 represents a subdivision within a county, and is typically not used.

48 is the State code for Texas

113 is the County code for Dallas County

Entering the entire 048113 code will cause the radio to receive all SAME alerts that match the code for Dallas County.

Suppose you wanted to receive any alert for any county in the entire state (provided that the alert is sent by your local NWS

transmitter). Using the wildcard feature you can enter a SAME area code as follows:

\*48\*\*\*

This tells the radio to alert on any SAME message with a location code that matches 48 for the state of Texas.

Your scanner also allows you to specify the event code. The default alert code is “\*\*\*”, which is best for most general purpose weather alert monitoring purposes. A list of event codes can be found at this web site:

[http://www.weather.gov/os/eas\\_codes.shtml](http://www.weather.gov/os/eas_codes.shtml)

Each SAME location/event code storage location can be configured for Entry ON/OFF and Lockout ON/OFF.

When a SAME location/event code storage location is set for Entry ON, the radio will process the SAME location/event code that is stored there. When a SAME location/event code storage location is set for Entry OFF, that SAME location and event code will be ignored.

When a SAME location/event code storage location is set for Entry ON *and* Lockout ON, the radio will process the SAME location/event code that is stored there, *and will lock out the specified event code*. A SAME location/event code storage location set for Entry: OFF and Lockout: ON will *not* be processed, because Entry is set to OFF. In case of a conflict (i.e., two identical codes and events are entered, and one is locked out), the *locked out entry will take precedence*.

### SAME Entry Examples

Using the Dallas County, TX example above:

SAME Entry 1:  
Code: 048113  
Event: \*\*\*  
Entry: ON  
Lockout: OFF

SAME Entries 2-10:  
Code: \*\*\*\*\*  
Event: \*\*\*  
Entry: OFF  
Lockout: OFF

*The above entry for 048113 will receive all SAME messages for 048113.*

SAME Entry 1:  
Code: 048113  
Event: \*\*\*  
Entry: ON  
Lockout: OFF

SAME Entry 2:  
Code: 048113  
Event: RWT  
Entry: ON  
Lockout: ON

*The above combination of entries for 048113 will receive all SAME messages for 048113, except the Required Weekly Test (RWT) message, since the second entry is ON, with lockout ON, and with RWT in the event field.*

SAME Entry 1:  
Code: 048113  
Event: \*\*\*  
Entry: ON  
Lockout: OFF

SAME Entry 2:  
Code: 048113  
Event: \*\*\*  
Entry: ON  
Lockout: ON

*The above combination of entries for 048113 will not receive any SAME messages for 048113, since the second entry is ON, with lockout ON, and with \*\*\* (all events wildcard) in the event field.*

The entry lockout feature should be used with caution so as not to inadvertently lock out desired SAME location or event codes.

### Entering SAME Location and Event Codes

The following steps are used to create a SAME entry that provides all weather alerts for a given location.

Press the WX key to enter Weather mode.

Press the SAME softkey to add or edit SAME entries. The scanner display will show the following:

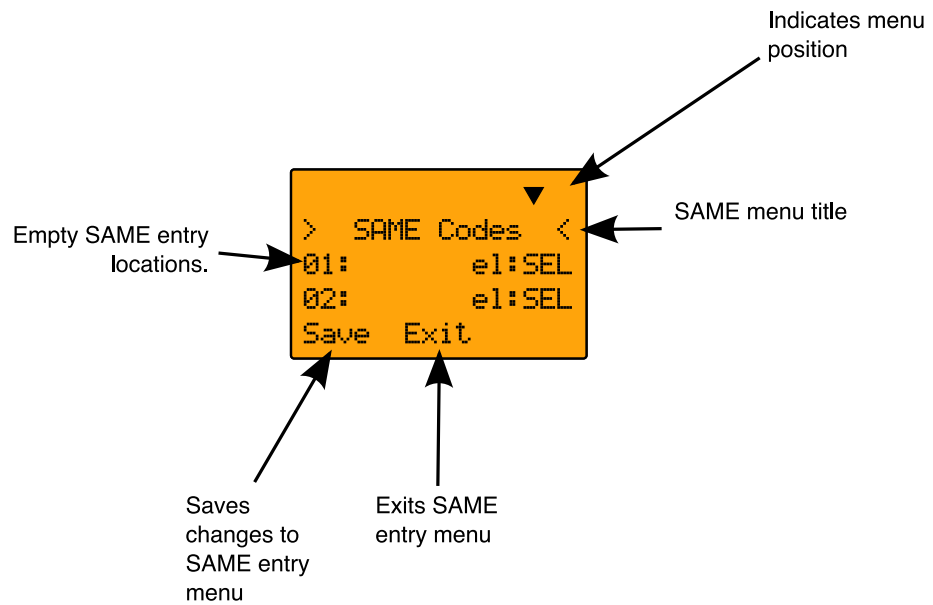

Use the ▲ or ▼ keys on the 5-way pushbutton pad to scroll to the desired SAME code entry.

Press the SEL key on the 5-way pushbutton pad to edit the selected SAME entry. The scanner display will appear as follows:

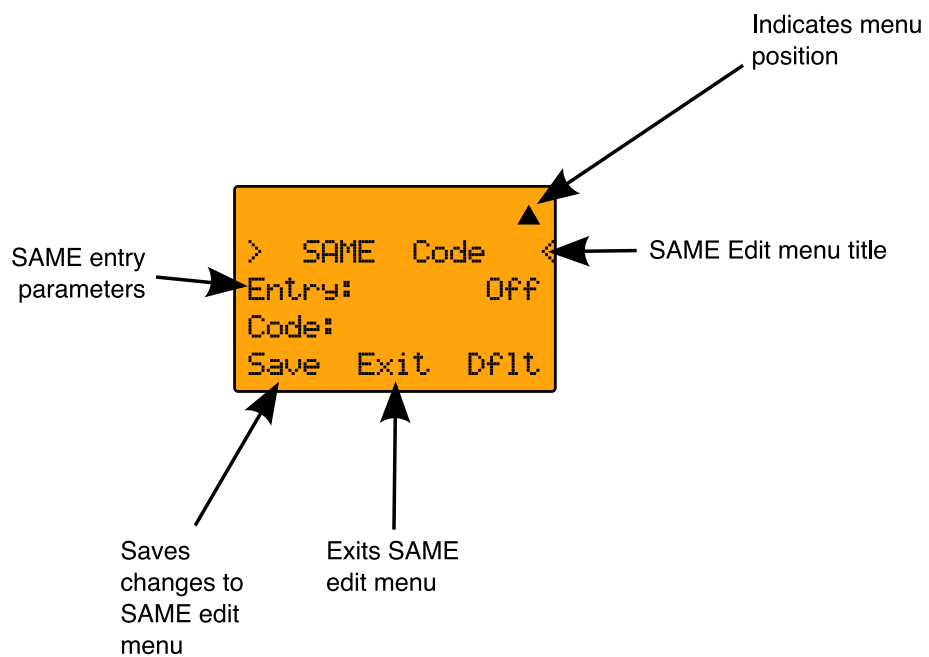

With the **Entry:** field selected, press ► on the 5-way pushbutton pad to turn the entry on.

Scroll to the **Code:** field and press **▶** on the 5-way pushbutton pad to enter a SAME location code. Use the keypad to enter a SAME code.



*NOTE: The PSR-500 supports entry of Extended SAME codes, which can include numbers and letters. The text entry mode is used to enter both numerical SAME codes and extended SAME codes. To enter a numerical SAME code, simply precede each number in the SAME code with "1". For example, to enter SAME code 048113, press*

10 14 18 11 11 13.

Scroll to the **Event:** field. Note the current default of **\*\*\*\***, which will allow all messages for the specified SAME location code. We recommend that you leave the event code with **\*\*\*\*** to receive all alerts.

Scroll to the **Tag:** field. We suggest that you enter a tag name here that corresponds with the SAME location code that you have entered. Press **▶** on the 5-way pushbutton pad to edit the tag name, and use the standard text entry method to enter your tag. Using our Dallas County example, you would enter the following:

```
31 D
21 A
53 L
53 L
21 A
74 S
. <space>
23 C
63 O
82 U
62 N
81 T
93 Y
```

Scroll to the **Alarm:** field. Note that you can specify different alarm sounds for this SAME entry. We recommend that you use the default setting here for general purpose weather alerting.

Scroll to the **Lockout:** field. Note that Lockout is currently set to off. Lockout is a special purpose parameter that can be used to lock out individual event or area codes. We recommend that you leave Lockout set to off for general purpose weather alerting.

When you have finished editing your SAME entry, press the **Save** softkey to store the data, then press the **Save** softkey to save all SAME changes and return to the Weather mode.

### Activating SAME Standby Mode

After you have entered your desired SAME codes, you can activate the SAME Standby Mode to begin standby operation. The radio will remain silent until a SAME transmission is received with a code that matches one that you have stored. When a matching SAME message is received, your radio will sound a siren alarm, then will play the audio message that follows the Warning Alert Tone (WAT).

To activate SAME standby mode, press the **WX** key, use the **▲** or **▼** keys to find the best weather radio transmitter for your location, then press the **STBY** softkey. The softkey will change to **STBY** to indicate that SAME Standby Mode is active, and the scanner will alert when a matching SAME message is received.

Press the **STBY** softkey again to exit SAME Standby Mode, or press **MAN**, **SCAN** or **PGM**.

When your local NWS office activates a SAME warning that matches a FIPS code stored in your scanner, you will first hear a siren alarm and see the LED flash to alert you to the incoming alarm. The LED flashes **RED** for warnings, **YELLOW** for watches, and **BLUE** for tests and administrative messages.

The scanner sounds the siren until the NWS transmission of the 1050 Hz Warning Alert Tone (WAT) begins. Once the WAT begins, the scanner's speaker will unmute, and you will hear the WAT play as an alert that the voice portion of the SAME warning is about to begin. You will then hear the voice portion of the SAME warning.

Your scanner will resume SAME Standby operation 90 seconds after the SAME warning starts. You may reset standby mode by pressing the **STBY** softkey twice at any time.

### **Using V-Scanner Storage**

Your PSR-500 features two types of memory storage. *Main memory* is used to store your programming that is used for everyday monitoring and scanning. *V-Scanner memory* is used to store complete copies of your scanner's main memory for later recall, including objects, global settings and dedicated search configurations. We call this feature *V-Scanner*, for "Virtual

Scanner". Your PSR-500 features 21 V-Scanner storage locations, each capable of storing a copy of your scanner's main memory, including all of your objects and global radio-wide settings.

Having 21 Virtual Scanners is like having 21 scanners in one. You can custom tailor a main memory configuration to suit your needs for the type of scanning you do in different situations, then store that configuration for later use. If you travel frequently, you may want to create V-Scanners for the areas where you travel.

V-Scanners are also useful for backing up your configurations. Once you have main memory configured the way you like it, you can save it to a V-Scanner where it will remain untouched until you delete, overwrite or recall it. Then, if you happen to make a mistake while using your main memory that you cannot fix, you can recall the backup data and start again.



*NOTE: V-Scanner storage is not unlike working with a hard drive on a personal computer. You save active scanner configurations (called "working" or "main" memory) to a V-Scanner storage folder for later use, and you recall stored scanner configurations from a V-Scanner storage folder to main memory when you want to use them. If you recall a configuration from a V-Scanner storage folder and use it in main memory, any changes you make while using the configuration will not automatically be transferred to the configuration data stored in the V-Scanner storage folder. You must save your changes back to that folder location if you want to preserve them for later use. When you load a new configuration into main memory, the contents of main memory are overwritten and lost, unless you save your main memory to a V-Scanner storage folder first. Once the configuration data in main memory has been overwritten, it cannot be recovered - there is no "Undo" function.*

V-Scanners provide a capability that is similar to having a computer with scanner programming software available all of the time. Instead of connecting the computer and transferring configuration files to and from main memory, you use V-Scanners to save or load main memory configurations in the field. Each V-Scanner storage location is called a *V-Scanner folder*. To begin V-Scanner operations, press FUNC PGM. The scanner display will appear as follows:

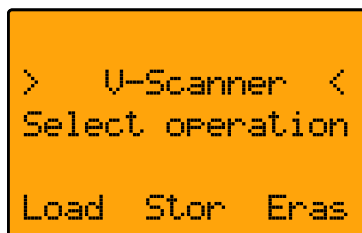

### Saving Main Memory To A V-Scanner Folder

To save the current contents of your scanner's main memory to a V-Scanner folder, press **FUNC**, then **PGM** to enter V-Scanner mode, then press the **Stor** softkey. Use the **▲ ▼** keys on the 5-way pushbutton pad to scroll to the desired V-Scanner folder, then press the **Stor** softkey.

If the selected V-Scanner folder already contains data, you will be asked if you wish to overwrite the existing data with new data from your current version of main memory. Press the **YES** softkey to proceed, or the **NO** softkey to cancel. If you decide the overwrite existing data, or if the selected V-Scanner folder is already empty, the scanner will prompt you to enter a name for the stored V-Scanner. The scanner uses the text from Line 4 of the Welcome Screen as a default name if the folder is empty, or the current name if the folder contains data. You can provide your own text here without overwriting the Line 4 Welcome Screen text. Use the standard text entry method to type the name you wish to use, then press the **OK** softkey. The scanner will write the contents of main memory to the V-Scanner folder. This will take approximately four seconds to complete.

### Loading A Stored V-Scanner Folder To Main Memory

To load the contents of a previously saved V-Scanner folder into your scanner's main memory, press **FUNC**, then **PGM** to enter V-Scanner mode, then press the **Load** softkey. Use the **▲ ▼** keys on the 5-way pushbutton pad to scroll to the desired V-Scanner folder, then press the **Load** softkey. The scanner will ask you to confirm that you wish to overwrite the current contents of main memory. Press the **YES** softkey to proceed, or the **NO** softkey to abort. The data transfer takes approximately 4 seconds to complete.



## Erasing V-Scanner Folders

You can erase V-Scanner folders when you no longer need them and wish to make the folder storage location available for other data.

To erase the contents of a previously saved V-Scanner folder, press **FUNC**, then **PGM** to enter V-Scanner mode, then press the **Erase** softkey. Use the **▲ ▼** keys on the 5-way pushbutton pad to scroll to the desired V-Scanner folder, then press the **Erase** softkey. The scanner will ask you to confirm that you wish to overwrite the current contents of the selected V-Scanner folder. Press the **YES** softkey to proceed, or the **NO** softkey to abort.

## **Cloning Your Radio to Another PSR-500 or PSR-600 Scanner**

Your PSR-500 features a high speed data interface that can be used to transfer the data from your scanner to another PSR-500 or PSR-600 scanner from GRE.

To clone your radio to another unit, use a standard stereo patch cord terminated with 1/8" male stereo phone plugs on each end to connect your radio (the **SOURCE** radio) to another radio (the **TARGET** radio). Ensure that both radios are powered on. Press the **PGM** key, then the **GLOB** softkey to enter the Global Settings menu. On the **SOURCE** radio, scroll to the **Clone Send:** option, then press the **SEL** key when you are ready to send data from your **SOURCE** radio to the **TARGET** radio. Both working memory and global settings are transferred.

Under certain circumstances the CCDump output may interfere with the cloning process. If you experience problems with cloning, ensure that CCDump is turned off by pressing the **PGM** key, then the **FUNC** key, then the **GLOB** softkey, then scrolling to the CCDump menu item. If necessary, turn CCDump off by pressing the left or right arrow key, then press the **Save** softkey to save the setting.



**NOTE:** *The contents of working memory on the TARGET radio will be overwritten immediately when SEL is pressed on the SOURCE radio.*

## **Standard Text Entry Method and QuickText**

Your PSR-500 features a high-contrast, backlit alphanumeric display that provides constant feedback about what the radio is

doing while scanning and monitoring your “Scannable Objects”. To get the most out of your scanner and this display, you will want to name your objects as you program them into the radio. This allows for easy identification of active objects while the radio is scanning, and makes it easier than ever to find objects that you wish to monitor, edit or delete using the powerful FIND feature.

Your scanner uses a simple text entry method that allows entry of all uppercase and lowercase letters of the alphabet, numbers, and punctuation symbols. Your scanner also features GRE’s exclusive QuickText feature, which allows you to store up to 10 commonly used text items for instant recall while editing alphanumeric fields.

## **Entering and Editing Alphanumeric Information**

A Standard Text Entry Method is used for entering alphanumeric information into the radio. This method allows easy access to each letter in the alphabet by pressing two keys that represent the letter.

Take a moment to study the numeric keys on the keypad and you will notice that keys 2-9 each have three or four letters silk screened on the front panel just above each key. To enter a letter in an alphanumeric text field, simply press the number key below the letter you wish to type first, then press the number key that corresponds with the position of the letter in the silk screen group. For example, the number 2 is used to access the letters A, B and C. To type the letter A, press 2 to select the ABC group, then 1 to select the first letter in the group, A. Likewise, to type the letter B, press 2 to select the ABC group, then press 2 again to select the second letter in the group. And, to type the letter C, simply press 2, then 3 to select the third letter in the “ABC” group.

To enter numbers in alphanumeric text fields, press 1 first, then the number you wish to type.

To enter punctuation, press 0 first to see the first set of punctuation, then press the number key that corresponds with the position of the desired punctuation mark in the set.

Press the . (period) key to enter a SPACE.

While using Standard Text Entry, the FUNC key serves as a shift key. For letters, uppercase text is typed by default, and you can

shift to lowercase by pressing the FUNC key before entering a character. For punctuation, the FUNC key accesses a second set of punctuation marks. The shift action of the FUNC key remains active until it is pressed again.

Use the ◀ ▶ keys to move the cursor to the desired location in edit fields. Press FUNC ◀ or FUNC ▶ to move the cursor to the beginning or end of an edit field, respectively. Use the CL key as a backspace key to erase characters before the cursor, and press FUNC CL to clear the entire field.

The PSR-500 character set and corresponding entry codes are provided below for reference. Pressing FUNC to toggle the shift lock status will produce lower case characters for letters, and a second set of punctuation marks for special characters. For brevity, lower case letters are not shown in the table below.

Char	Code	Char	Code	Char	Code	Char	Code
A	21	O	63	3	13	?	07
B	22	P	71	4	14	→	08
C	23	Q	72	5	15	‘	09
D	31	R	73	6	16	←	00
E	32	S	74	7	17	.	(F)01
F	33	T	81	8	18	-	(F)02
G	41	U	82	9	19	#	(F)03
H	42	V	83	0	10	_	(F)04
I	43	W	91	\$	01	@	(F)05
J	51	X	92	%	02	+	(F)06
K	52	Y	93	!	03	*	(F)07
L	53	Z	94	^	04	&	(F)08
M	61	1	11	(	05	/	(F)09
N	62	2	12	)	06	,	(F)00

## Using QuickText

QuickText allows you to store up to 10 commonly used text items for instant recall while editing alphanumeric fields. For example, as you search for, store and name new CONV or TGRP objects,



## ***Power-On Configuration Key Sequences***

Your PSR-500 features power-on keypress sequences that are used as shortcuts to configuration items, like attenuator settings, backlight settings and memory information. Power-on key sequences are also used to place your scanner into firmware upgrade mode for CPU and DSP firmware upgrades.

The following table lists the power-on key sequences available in the PSR-500. Unless otherwise specified, each sequence is invoked by pressing and releasing each key in sequence, one at a time. The first key must be pressed while the Welcome/Owner screen is being displayed:

Key Sequence	Function
1	Shortcut to PGM>GLOB>Sound Mode
2	Shortcut to PGM>GLOB>Key Beeps
3	Displays Boot, CPU and DSP versions
	Shortcut to PGM>GLOB>Light Mode
ATT	Shortcut to PGM>GLOB>Atten Mode
0, 0	Shortcut to PGM>GLOB>Memory Info
0, 1	Destructive, clears working memory and resets all Global settings to factory defaults. Does not affect V-Scanners.
0, 2	Destructive, resets all Global settings to factory defaults. Does not affect working memory or V-Scanners.
0, 5	Destructive, executes EEPROM memory test, then clears working memory and resets all Global settings to factory defaults. Does not affect V-Scanners.
0, CL	Erases DSP APP Upgrade code, restores factory DSP version
0, PGM	Places radio in DSP APP firmware upgrade mode
Hold PGM while powering on radio	Places radio in CPU firmware upgrade mode

## ***Birdie Frequencies***

Every scanner has birdie frequencies. Birdies are signals created inside the scanner's receiver. These operating frequencies might interfere with transmissions on the same frequencies. If you program one of these frequencies, you hear only noise on that frequency. If the interference is not severe, you might be able to turn SQ clockwise to omit the birdie.

To find the birdies in your scanner, begin by disconnecting the antenna and moving it away from the scanner. Make sure that no

other nearby radio or TV sets are turned on near the scanner. Use the TUNE function and scan every frequency range from its lowest frequency to the highest. Occasionally, the searching will stop as if it had found a signal, often without any sound. This is a birdie. Make a list of all the birdies in your scanner for future reference.

## **Care**

Keep the scanner dry; if it gets wet, wipe it dry immediately. Use and store the scanner only in normal temperature environments. Handle the scanner carefully; do not drop it. Keep the scanner away from dust and dirt, and wipe it with a damp cloth occasionally to keep it looking new.

Modifying or tampering with the scanner's internal components can cause a malfunction and might invalidate its warranty and void your FCC authorization to operate it.

## **In Case of Fault**

If you believe your scanner is defective, you should contact your dealer for assistance. However, before you do so, check that the fault was caused by a human error. Carefully reread the relevant section in the Owners Manual.

## Troubleshooting

If you have problems with your scanner, please refer to the following chart for some suggestions that might help you eliminate the problem. If the scanner is still not operating correctly after trying these tips, contact the dealer where you purchased your scanner for assistance.

### Troubleshooting Chart

Problem	Possible Cause	Remedy
Poor reception	Weak signals from distant stations	Reposition radio for best reception
	Attenuator in use on weak signals	Check performance with and without attenuator activated, use setting with best reception
	Strong signal overload from nearby transmitter(s)	Check performance with and without attenuator activated, use setting with best reception
	Loose or defective antenna	Inspect antenna and connectors and correct any problems found
	Incorrect modulation mode selected	Ensure that the proper modulation mode is selected for the type of system that is being monitored
<i>Scanner will not power on</i>	AC or DC power supply not properly connected	Check connection to AC or DC power source
	Dead batteries	Replace or recharge batteries
<i>The keypad does not work</i>	The scanner may need to be initialized	Follow steps below to initialize the scanner
<i>Scanner will not scan when SCAN key is pressed</i>	Possible "birdie" frequency programmed	Tighten squelch, apply attenuator or lock out the "birdie" frequency
	The scanner may need to be reset or initialized	Follow steps to reset/reinitialize the scanner following this table
	No channels programmed, or only one channel programmed, or all channels locked out	Ensure that the scanner has more than one channel programmed and enabled for scanning
	SQUELCH control is not adjusted properly	Turn SQUELCH control clockwise until scanning resumes
The scanner does not receive digital transmissions on digital frequencies or trunking systems	The digital channel or talkgroup is not using APCO-25 digital modulation	The scanner can only receive APCO-25 C4FM/CQPSK IMBE digital signals
	The digital channel or talkgroup is encrypted	The scanner will not receive encrypted traffic
	The digital channel or talkgroup is being transmitted from a distant location	Reposition the scanner or use an outdoor antenna to improve reception

### Initializing Global Parameters to Factory Defaults

If your scanner does not appear to be functioning properly, you can reset the global radio parameters to their factory state without losing any of your programmed data. Any custom changes you have made to the radio's global parameters will be lost.





**NOTE:** *This procedure preserves the information you stored in the scanner's working memory, while resetting all global radio parameters to factory defaults. V-Scanner memory is not affected by this operation.*

1. Turn off the scanner, then turn it on again. The scanner briefly displays the DSP boot version, and then the Welcome/Owner screen is displayed.
2. Press 0 while the scanner is displaying the Welcome/Owner screen. The scanner displays

```
System Tests:  
Select a Test...  
Exits if no key  
is Pressed
```

3. Press 2. The scanner displays

```
Init GLOB data  
To factory state  
ENTER if APPROVE  
CLEAR to EXIT
```

4. Press ENT. The scanner displays

```
GLOB EEPROM area  
Initialized to  
defaults.  
Press any key.
```

5. Press any key on the keypad to proceed. The scanner will reboot with file system and global parameters reset to factory defaults.

## Initializing the Scanner to Factory Defaults

If initializing the global parameters to factory defaults does not resolve your problem, you may wish to initialize the entire scanner to factory defaults. This operation will result in the clearing of your programmed data and the loss of any custom changes you have made to the radio's global parameters. Use this option as a last result, and, if possible, save your working memory to a V-Scanner folder prior to performing this operation.



**NOTE:** *This procedure clears all information you stored in the scanner's working memory, AND resets the global parameters to factory defaults. Initialize the scanner only when you are sure the scanner is not working properly. V-Scanner memory is not affected when the scanner is initialized.*

1. Turn off the scanner, then turn it on again. The scanner briefly displays the DSP boot version, and then the Welcome/Owner screen is displayed.

2. Press 0 while the scanner is displaying the Welcome/Owner screen. The scanner displays

```
System Tests:  
Select a Test...  
Exits if no key  
is pressed
```

3. Press 1. The scanner displays

```
Factory Init  
Erase Memory  
ENTER if APPROVE  
CLEAR to EXIT
```

4. Press ENT. The scanner displays

```
Initializing the  
File System  
Please Wait.....
```

Then,

```
File System  
Initialized to  
Defaults.  
Press any key.
```

5. Press any key on the keypad to proceed. The scanner will next display:

```
GLOB EEPROM area  
Initialized to  
defaults.  
Press any key.
```

6. Press any key on the keypad to proceed. The scanner will reboot with file system and global parameters reset to factory defaults.

## Detailed Menu Reference

Your PSR-500 scanner uses GRE's exclusive Object Oriented User Interface, which features a powerful menu system that is used to configure the various Scannable Objects that your scanner is capable of receiving. The PSR-500 design also includes a Global Settings (GLOB) menu that provides unprecedented control over the radio wide settings used throughout your scanner. This section of the manual provides detailed information about all of the menus and menu parameters.

Each menu parameter features a **Dfl** softkey that can be used to restore the value to the factory defaults. This can be very useful if you make a change to a parameter but do not like the result.



*HINT: Remember that context sensitive help is available for every menu parameter. Press FUNC SEL to view help for the selected parameter. Press SEL to exit help.*



*HINT: It's easy to fix things if you inadvertently change a parameter and then can't remember how to make it right again. Each parameter includes a **Dfl** softkey, which, when pressed, restores the factory default setting for that parameter.*



*HINT: If you think you've really messed the Global settings up, you can reset every global parameter back to factory defaults without altering your programmed objects. Turn the radio off, then on again. While the "Welcome" screen is being displayed, press and release 0, then press and release 2. Press ENT to confirm the reset of all global parameters to their factory defaults.*



*NOTE: The Special Global Settings menu (FUNC GLOB) includes parameter settings that, if not set properly, may adversely affect the performance of your radio. We recommend that users not change the settings found in the FUNC GLOB menu unless instructed to in this manual or directed to do so by GRE Technical Support personnel. Should you experience difficulties after changing any of the settings in the FUNC GLOB menu, you can also restore those settings to factory defaults by pressing the **Dfl** softkey associated with each menu line, or following the 0,2 global settings reset procedure described above.*

## GLOB Menu Reference

The GLOB menu stores all of the radio-wide settings used by the scanner. The GLOB menu allows you to “tweak” these settings to your liking. The default settings will work fine for most users, but most users will want to use the GLOB menu to personalize the radio to suit their individual tastes. The active parameter is always the middle parameter and is indicated by a flashing “▣”. The entire GLOB menu is shown below. Note that some GLOB parameter changes do not take effect until the GLOB menu is saved.



**HINT:** You can restore all GLOB settings to their defaults without affecting your programmed objects or V-Scanners. Power cycle the radio, then press 0, then 2 during the welcome message display. Press ENT to confirm the GLOB parameter reset.

GLOB Parameter	Options	Description
CONTRAST	1-7	Sets LCD contrast. Use ◀ ▶ keys on 5-way pushbutton pad.
Owner	SEL	Enters sub menu to set Welcome Message text display.
Clone Send	SEL	Press SEL to send data using clone mode
Alert Mode	Both, Tone, Light, Off	Controls the ALERT LED and Audible Alarm behavior. Both allows the LED and Tone. Tone allows the audible alarm only. Light allows the LED only. Off deactivates the ALERT LED and Audible Alarm feature.
Sound Mode	Key or Stlth	Controls all radio beeps.
Key Beeps	On or Off	Controls key beeps.
Light Mode	Norml, Key, Ignre, On, Stlth	Controls the backlight operation. Norml (Normal) uses the backlight key on the keypad. Key activates the backlight when any key is pressed. Ignore activates the backlight when a key is pressed, and that key's normal function is ignored if the backlight is off when it is pressed. On causes the backlight to remain on all the time. Stlth (Steath) disables the backlight.

<b>GLOB Parameter</b>	<b>Options</b>	<b>Description</b>
Light Area	Both, LCD, Keybd	Controls what area is illuminated when the backlight is on. Both illuminates the LCD and the keypad, LCD illuminates the display only. Keybd (Keyboard) illuminates the keypad only.
Light Secs	1-99 seconds	Controls the amount of time the backlight remains on for Normal, Key and Ignore light modes
Battery	NiMH, Alkaline or NiCad	Loads low battery profile for each different battery type.
Lo Batt Alert	0-60 seconds	Controls critical battery audible alert. 0=off.
Battery Info	SEL	Displays current battery voltage, DAC value and charge time remaining if battery is charging.
Charge Time	0-99	Battery charge time in hours. 0=charger off. The battery charger is timer based and charges at a current rate of 150 mA. The charger is disabled when BATTERY is set to Alkaline. A default charge time of 9 hours is used for NiCAD batteries, and 16 hours for NiMH batteries.
Atten Mode	Global or Normal	The attenuator reduces the amount of signal at the receiver input. This helps reduce interference from strong nearby transmitters. Global attenuator mode applies attenuation radio-wide, regardless of individual object settings. In Normal attenuator mode, the attenuator follows the individual object attenuator setting.
Global Atten	On or Off	When the ATTEN mode is set to Global, this controls whether the Global attenuator is on or off.
Clear Hits	SEL	Press SEL to clear all hit counters.
Hit Counts	Yes or No	Turns the hit counter feature on or off.
Dflt ScanList	0-22	Sets default destination Scan Lists for new objects and CONV Stor from Searches, Spectrum Sweeper and Tune. Use 1-20 for "normal" Scan Lists 1-20. Use 0 for the "ns" (not scanned) Scan List (no Scan List mappings are specified). Use 21 for the FAV Scan List. Use 22 for the SKYWARN Scan List.
Priority	On or Off	Turns Priority Scan On or Off. Priority Scan can also be toggled by pressing FUNC PRI while scanning.
WxPri	On or Off	Toggles Weather Priority Mode on or of. Also accessed by pressing WX, then PRI
Scan Lists	SEL	Enters sub menu for Scan List settings and status
SRCH L/Outs	SEL	Enters sub menu for review, editing or deletion of search lockout frequencies
Clear FAV	SEL	Press SEL to clear the Favorites Scan List.
Memory Info	SEL	Press SEL to see the current memory usage.
<b>EXPERT BELOW</b>		
Tune LED	On or Off	Activates Signal Strength driven LED when in TUNE mode.

<b>GLOB Parameter</b>	<b>Options</b>	<b>Description</b>
Color 0-7	Red/Green/Blue (RGB) value	Sets intensity of red, green and blue LEDs. Press SEL to edit colors. Use ◀ ▶ keys to scroll to R, G or B LED settings. Use numeric keys to activate preset intensity levels for each LED, or use ▲ ▼ keys to fine scroll intensity.
Qtxt1-0	Text value	Sets QTXT (QuickText) 0-9 text. Use "\$" to indicate end of text.
Key Repeat	On or Off	Toggles key repeat mode when a key is held down
LCD BlinkOff	1-250 x 10 mS	For alternating text displays, sets the display time for the secondary display element.
LCD BlinkOn	1-250 x 10 mS	For alternating text displays, sets the display time for the primary display element.
LED BlinkOff	1-250 x 10 mS	When the ALERT LED setting for an object is set to Flash, this is the amount of time the LED stays turned off.
LED BlinkOn	1-250 x 10 mS	When the ALERT LED setting for an object is set to Flash, this is the amount of time the LED stays turned on.
Pri Channels	0-250	Number of priority CONV channels to check during a priority scan sampling. "0" samples all CONV priority channels.
Pri Interval	2-100 x 100 mS	Conventional frequency priority sample interval.
TGRP Pri Int	On or Off	Toggles priority interrupt scanning during trunked calls
QuickPriRtn	On or Off	When on, does not wait for verification of correct CTCSS, DCS or NAC when returning to an active CONV channel after priority sampling
Search Delay	1-100 x 100 mS	Sets wait for reply delay for all search modes
SRCH Dis AGC	On or Off	Sets digital AGC mode on or off for all search types. Useful to compensate for low or high digital audio levels caused at the system.
SRCH SuprTrk	On or Off	Alternative DSP decoding algorithm is applied to all search types. May help reception on some systems.
TLO=FUNC L/O	On or Off	Controls the operation of the L/OUT key. When Off, pressing L/OUT performs a Temporary Lockout of the selected object. When On, pressing L/OUT performs a Permanent Lockout of the selected object.
DupeChecksSQ	Yes or No	If set to Yes, dupe checking will check both the stored frequency and any encoded squelch settings when checking for duplicate CONV objects.
TGID Format	Norm, DEC or HEX	Selects TGID display format
TGRP Ignore	Yes or No	If set to Yes, TGRP wildcards will ignore calls on previously stored TGRPS that are mapped to disabled Scan Lists.
ShowCCInfo	Yes or No	For Motorola and P25 systems, shows current control channel index (from TSYS frequency list) and frequency alternating with the voice frequency.

## CONV Menu Reference

The CONV menu is used when creating new Conventional Channel objects, or editing existing Conventional Channel objects. All menus are shown in the scanner's display as a three line window that can be scrolled up or down to access the various different parameters. The active parameter is always the middle parameter and is indicated by a flashing "█". The entire CONV menu is shown below:

CONV Parameter	Options	Description
Scan Lists	On or Off for Scan Lists 1-20	Sets membership in Scan Lists. Use ◀ ▶ keys to scroll through Scan Lists. Use SEL key to toggle Scan List membership. A "█" next to the Scan List number indicates that the object is mapped to that Scan List.
Freq	Any supported frequency in MHz	The frequency that the CONV object will use.
Tag	Alpha-numeric text	The alphanumeric display name for the CONV channel. Use the standard text entry method or QTXT to name the object.
Sq Mode	Search, None, CTCSS, DCS, P25	Sets subaudible squelch mode or Project 25 conventional digital modulation. Use Search to automatically analyze signals to determine squelch mode and code. Use None to ignore subaudible squelch. Use CTCSS for tone coded squelch, DCS for digital coded squelch, or P25 for Project 25 conventional digital operation. Used in conjunction with Squelch Code parameter below.
Squelch Code	CTCSS Hz, DCS Code, P25 NAC	Sets CTCSS tone, DCS code, or P25 NAC depending on Sq Mode setting. Use Search to detect tone or code value for selected squelch type.
L/Out	On or Off	Permanent lockout for the CONV channel. Also accessed by pressing FUNC L/OUT while the scanner is stopped on the CONV object.
Priority	On or Off	Turns Priority Mode on or off for the CONV object.
LED Mode	Solid or Flash	Controls whether the ALERT LED flashes or remains on solid when the ALERT LED is used.
LED Color	0-7	Sets LED color to 0-7 as defined in the GLOB menu. By default, 0=LED Off, 1=Red, 2=Yellow, 3=Green, 4=Cyan, 5=Blue, 6=Magenta, 7=White.
Latch LED	On or Off	Normally the ALERT LED is active only while the object is receiving a transmission. When Latch is on, the ALERT LED will remain lit after the transmission is complete, unless overridden by a subsequent object that is also using the ALERT LED.
Backlight	On, Off or Flash	Controls whether the backlight should be on, off or flashing while the object is active.

Alarm	None, Chirp, Hi-Lo, Alert, Ring, 2-Chirp, Fast Hi-Lo, DTMF#	Sets the Audible Alarm for the CONV object. When an Audible Alarm is selected, the selected alarm will play at the beginning of each transmission on the CONV object, or anytime the scanner stops for activity on the CONV object while scanning.
Fav	On or Off	When On, the CONV object is a member of the Favorites Scan List.
Skywarn	On or Off	When On, the CONV object is a member of the Skywarn Scan List.
<b>EXPERT BELOW</b>		
Modulation	AM, FM, NFM, AU	Modulation setting for the CONV channel. In most cases AU will work fine. Use AM to override and force AM modulation, FM to force FM modulation, NFM to force narrow FM modulation.
Atten	On or Off	When on, applies 20 dB of attenuation to all transmissions on the CONV channel. Useful in areas where interference from nearby strong signals is present.
Delay	On or Off	Controls whether a Delay is used to wait for reply traffic after a transmission on the CONV channel.
Delay Time	1-200	Sets the amount of time (in 100 millisecond intervals) for the wait for reply delay if Delay is On, e.g., 20=2 seconds.
Digital AGC	On or Off	Controls Digital AGC function for the CONV channel
Supertrack	On or Off	Alternative DSP decoding algorithm. May help reception on some systems.
AudioBoost	On or Off	Applies a 6 dB boost to audio levels when the object is active
Hit Count	Numeric value	Increments each time a transmission is received on the SWPR object. Global "Hit Counts" must be set to ON. Press the <b>Dflt</b> softkey to reset to 0.



## TGRP Menu Reference

The TGRP menu is used when creating new Trunking Talkgroup objects, or editing existing Trunking Talkgroup objects. All menus are shown in the scanner's display as a three line window that can be scrolled up or down to access the various different parameters. The active parameter is always the middle parameter and is indicated by a flashing "⚡". The entire TGRP menu is shown below:

TGRP Parameter	Options	Description
Scan Lists	On or Off for Scan Lists 1-20	Sets membership in Scan Lists. Use ◀ ▶ keys to scroll through Scan Lists. Use SEL key to toggle Scan List membership. A "⚡" next to the Scan List number indicates that the object is mapped to that Scan List.
TSYS	New or previously stored trunking system object (TSYS)	To enter a new trunking system, use the ◀ ▶ keys to scroll through the stored systems until NEW appears, then press SEL to enter the parameters for the new TSYS. To use a trunking system that you have previously entered, use the ◀ ▶ keys to scroll to the desired system.
ID	Decimal, hex or AFS depending on TSYS type	The digital address of the talkgroup or individual radio ID on the trunked radio system.
Type	Group or Private	Use Group for talkgroup ID, Private for individual radio ID.
Tas	Alpha-numeric text	The alphanumeric display name for the TGRP. Use the standard text entry method or QTXT to name the object.
L/Out	On or Off	Permanent lockout for the TGRP. Also accessed by pressing FUNC L/OUT while the scanner is stopped on the TGRP object.
Priority	On or Off	Turns Priority Mode on or off for the TGRP object.
LED Mode	Solid or Flash	Controls whether the ALERT LED flashes or remains on solid when the ALERT LED is used.
LED Color	0-7	Sets LED color to 0-7 as defined in the GLOB menu. By default, 0=LED Off, 1=Red, 2=Yellow, 3=Green, 4=Cyan, 5=Blue, 6=Magenta, 7=White.
Latch LED	On or Off	Normally the ALERT LED is active only while the object is receiving a transmission. When Latch is on, the ALERT LED will remain lit after the transmission is complete, unless overridden by a subsequent object that is also using the ALERT LED.
Backlight	On, Off or Flash	Controls whether the backlight should be on, off or flashing while the object is active.
Alarm	None, Chirp, Hi-Lo, Alert, Ring, 2-Chirp, Fast Hi-Lo, DTMF#	Sets the Audible Alarm for the TGRP object. When an Audible Alarm is selected, the selected alarm will play at the beginning of each transmission on the TGRP object, or anytime the scanner stops for activity on the TGRP object while scanning.

Fav	On or Off	When On, the TGRP object is a member of the Favorites Scan List.
Skywarn	On or Off	When On, the CONV object is a member of the Skywarn Scan List.
<b>EXPERT BELOW</b>		
Delay	On or Off	Controls whether a Delay is used to wait for reply traffic after a transmission on the TGRP.
Delay Time	1-200 x 100 mS	Sets the amount of time (in 100 millisecond intervals) for the wait for reply delay if Delay is On, e.g., 20=2 seconds.
AudioBoost	On or Off	Applies a 6 dB boost to audio levels when the object is active
Hit Count	Numeric value	Increments each time a transmission is received on the SWPR object. Global "Hit Counts" must be set to ON. Press the <b>Dflt</b> softkey to reset to 0.

## TSYS Menu Reference

The TSYS menu is used when creating new Trunking System objects, or editing existing Trunking System objects. All menus are shown in the scanner's display as a three line window that can be scrolled up or down to access the various different parameters. The active parameter is always the middle parameter and is indicated by a flashing "⏏". The entire TSYS menu is shown below:

TSYS Parameter	Options	Description
Type	MOT 800/900, MOT VHF/UHF, P25 MANUAL, P25 AUTO, EDACS STD, EDACS NAROW, LTR	Sets the trunking system type. Choose MOT800/900 if the system is a Motorola 800 or 900 MHz analog or digital trunked radio system that uses the 3600 baud control channel. Use P25 AUTO for most Project 25 systems that send channel table information over the system control channel. Use P25 MANUAL if it is necessary to manually set the channel table information or if you wish to use the default 800 MHz table data. Use EDACS STD for most 800 MHz EDACS systems using the 9600 BPS EDACS control channel. Use EDACS NAROW for most 900 MHz and some VHF/UHF EDACS systems using the 4800 BPS EDACS control channel. Use LTR for Logic Trunked Radio (LTR) systems.
Tag	Alpha-numeric text	The alphanumeric display name for the TSYS. Use the standard text entry method or QTXT to name the object.
Frequencies	SEL	Press SEL to enter trunked radio system frequencies. Enter control channel frequencies in any order for all Motorola and Project 25 trunking systems. Enter system frequencies in LCN order for all EDACS trunking systems. Enter system frequencies in Home Repeater order for LTR systems.
L/Out	On or Off	Permanent lockout for the TSYS. When On, no traffic will be received on any programmed TGRPs for this TSYS.
<b>EXPERT BELOW</b>		
Atten	On or Off	When on, applies 20 dB of attenuation to all transmissions on this TSYS. Useful in areas where interference from nearby strong signals is present.
Narrow FM	Yes or No	Use Yes when the system is known to use Narrow FM modulation. Most 900 MHz analog trunked radio systems utilize NFM modulation. This setting has no effect on digital trunked radio system performance.
AudioBoost	Yes or No	Activates 6 dB audio level boost for all activity on this TSYS

TSYS Parameter	Options	Description
Dwell	0-200 x 100 mS	Sets the amount of time the scanner dwells on a Motorola, P25 or EDACS system control channel for activity on programmed talkgroups. Use 0 for automatic mode, which uses control channel information to determine when all current talkgroup information has been broadcast by the system.
Digital AGC	On or Off	Controls Digital AGC function for the TSYS
Supertrack	On or Off	Alternative DSP decoding algorithm. May help reception on some systems.
Multi-Site	Off, Roam or Stat (Stationary)	Used with networked Motorola and P25 trunked radio systems. When Multi-Site=Off, the scanner will find the first usable control channel in the control channel list and use it to track the system. When Multi-Site=ROAM, the scanner will always attempt to lock on to control channels where the decoding quality is greater than Threshold Hi, and will search for new control channels when the decoding quality of a control channel drops below Threshold Lo, and, if no control channels are available that meet the Threshold Hi criteria, the scanner will seek the best control channel to use, and continue checking periodically for a new control channel that meets the Threshold Hi criteria. When Multi-Site=STAT, the scanner will track the system using every usable control channel in the control channel list.
Threshold Hi	1-99	Available When Multi-Site is set to ROAM. Sets the control channel decode % threshold for a site to be considered good when looking for a new site.
Threshold Lo	1-99	Available When Multi-Site is set to ROAM. Sets the control channel decode % threshold for a site to be considered out of range, which will begin the process of looking for a new site.
T Tables	Normal, Splinter, Custom	For Motorola and P25 systems only - sets custom channel tables. Use ◀ ▶, to select option, press SEL on Custom to enter custom table information
Fleet Map	SEL	For Motorola Type I systems only - sets fleet map

## LMIT Menu Reference

The LMIT menu is used when creating new Limit Search objects, or editing existing Limit Search objects. All menus are shown in the scanner's display as a three line window that can be scrolled up or down to access the various different parameters. The active parameter is always the middle parameter and is indicated by a flashing "⌘". The entire LMIT menu is shown below:

LMIT Parameter	Options	Description
Scan Lists	On or Off for Scan Lists 1-20	Sets membership in Scan Lists. Use ◀ ▶ keys to scroll through Scan Lists. Use SEL key to toggle Scan List membership. A "⌘" next to the Scan List number indicates that the object is mapped to that Scan List.
FrLO	Any supported frequency in MHz	A frequency that will be used as the lower limit for the limit search range
FrHi	Any supported frequency in MHz	A frequency that will be used as the upper limit for the limit search range
Tae	Alpha-numeric text	The alphanumeric display name for the LMIT search. Use the standard text entry method or QTXT to name the object.
L/Out	On or Off	Permanent lockout for the LMIT channel. Also accessed by pressing FUNC L/OUT while the scanner is stopped on the LMIT object.
LED Mode	Solid or Flash	Controls whether the ALERT LED flashes or remains on solid when the ALERT LED is used.
LED Color	0-7	Sets LED color to 0-7 as defined in the GLOB menu. By default, 0=LED Off, 1=Red, 2=Yellow, 3=Green, 4=Cyan, 5=Blue, 6=Magenta, 7=White.
Latch LED	On or Off	Normally the ALERT LED is active only while the object is receiving a transmission. When Latch is on, the ALERT LED will remain lit after the transmission is complete, unless overridden by a subsequent object that is also using the ALERT LED.
Backlight	On, Off or Flash	Controls whether the backlight should be on, off or flashing while the object is active.
Alarm	None, Chirp, Hi-Lo, Alert, Ring, 2-Chirp, Fast Hi-Lo, DTMF#	Sets the Audible Alarm for the LMIT object. When an Audible Alarm is selected, the selected alarm will play anytime the scanner stops for activity on the LMIT object while scanning.
Fav	On or Off	When On, the LMIT object is a member of the Favorites Scan List.
<b>EXPERT BELOW</b>		
Modulation	AM, FM, NFM, AU	Modulation setting for the LMIT search. In most cases AU will work fine. Use AM to override and force AM modulation, FM to force FM modulation, NFM to force narrow FM modulation.
Atten	On or Off	When on, applies 20 dB of attenuation to all hits received on the LMIT search. Useful in areas where interference from nearby strong signals is present.

<b>LIMIT Parameter</b>	<b>Options</b>	<b>Description</b>
Delay	On or Off	Controls whether a Delay is used to wait for reply traffic after a transmission is received during the LIMIT search.
Delay Time	1-200	Sets the amount of time (in 100 millisecond intervals) for the wait for reply delay if Delay is On, e.g., 20=2 seconds.
Zeromatic	On or Off	When on, enhances the scanner's ability to lock on to the actual center frequency of a search hit instead of an adjacent frequency.
Search Dir	Up or Down	Sets search direction used when LIMIT object is active.
Hit Count	Numeric value	Increments each time a transmission is received on the SWPR object. Global "Hit Counts" must be set to ON. Press the <b>Df1</b> softkey to reset to 0.

## SRVC Menu Reference

The SRVC menu is used when creating new Service Search objects, or editing existing Service Search objects. All menus are shown in the scanner's display as a three line window that can be scrolled up or down to access the various different parameters. The active parameter is always the middle parameter and is indicated by a flashing "⌘". The entire SRVC menu is shown below:

SRVC Parameter	Options	Description
Scan Lists	On or Off for Scan Lists 1-20	Sets membership in Scan Lists. Use ◀ ▶ keys to scroll through Scan Lists. Use SEL key to toggle Scan List membership. A "⌘" next to the Scan List number indicates that the object is mapped to that Scan List.
SRVC	Pub Safety, Aircraft, Amateur, CB, Marine, FRS/ GM/MURS, Railroad	<p>Public Safety (Pub Safety) - Searches commonly used public safety frequencies. Groups are as follows:            0: 33.4-46.5 MHz            1: 151-170 MHz            2: 453-467 MHz            3: 764-806 MHz            4: 851-869 MHz</p> <p>Aircraft - Searches civilian and military air frequencies. Groups are as follows:            0: 108-118 MHz            1: 118-137 MHz            2: 138-150 MHz            3: 225-400 MHz</p> <p>Amateur - Searches amateur radio frequencies. Groups are as follows:            0: 28.0-29.7 MHz            1: 50-54 MHz            2: 144-148 MHz            3: 222-225 MHz            4: 420-450 MHz            5: 902-928 MHz            6: 1240-1300 MHz</p> <p>CB - Searches the citizen's band radio frequencies</p> <p>Marine - Searches the VHF-FM marine radio band</p> <p>FRS/GMRS/MURS/DOT/STAR (F/G/MURS) - Searches the FRS, GMRS, MURS, DOT and STAR radio frequencies</p> <p>Railroad - searches the Association of American Railroads (AAR) VHF railroad frequencies used in the US and Canada</p>
GROUPS	◀ ▶ to scroll, SEL to toggle on/off	Toggle search groups when Pub Safety, Aircraft and Amateur service searches are used.

SRVC Parameter	Options	Description
Tae	Alpha-numeric text	The alphanumeric display name for the SRVC search. Use the standard text entry method or QTXT to name the object.
L/Out	On or Off	Permanent lockout for the SRVC object. Also accessed by pressing FUNC L/OUT while the scanner is stopped on the SRVC object.
LED Mode	Solid or Flash	Controls whether the ALERT LED flashes or remains on solid when the ALERT LED is used.
LED Color	0-7	Sets LED color to 0-7 as defined in the GLOB menu. By default, 0=LED Off, 1=Red, 2=Yellow, 3=Green, 4=Cyan, 5=Blue, 6=Magenta, 7=White.
Latch LED	On or Off	Normally the ALERT LED is active only while the object is receiving a transmission. When Latch is on, the ALERT LED will remain lit after the transmission is complete, unless overridden by a subsequent object that is also using the ALERT LED.
Backlight	On, Off or Flash	Controls whether the backlight should be on, off or flashing while the object is active.
Alarm	None, Chirp, Hi-Lo, Alert, Ring, 2-Chirp, Fast Hi-Lo, DTMF#	Sets the Audible Alarm for the SRVC object. When an Audible Alarm is selected, the selected alarm will play anytime the scanner stops for activity on the SRVC object while scanning.
Fav	On or Off	When On, the SRVC object is a member of the Favorites Scan List.
<b>EXPERT BELOW</b>		
Modulation	AM, FM, NFM, AU	Modulation setting for the SRVC search. In most cases AU will work fine. Use AM to override and force AM modulation, FM to force FM modulation, NFM to force narrow FM modulation.
Atten	On or Off	When on, applies 20 dB of attenuation to all hits received on the SRVC search. Useful in areas where interference from nearby strong signals is present.
Delay	On or Off	Controls whether a Delay is used to wait for reply traffic after a transmission on the SRVC search.
Delay Time	1-200	Sets the amount of time (in 100 millisecond intervals) for the wait for reply delay if Delay is On, e.g., 20=2 seconds.
Zeromatic	On or Off	When on, enhances the scanner's ability to lock on to the actual center frequency of a search hit instead of an adjacent frequency.
Search Dir	Up or Down	Sets search direction used when SRVC object is active.
Hit Count	Numeric value	Increments each time a transmission is received on the SWPR object. Global "Hit Counts" must be set to ON. Press the Df1t softkey to reset to 0.



## SWPR Menu Reference

The SWPR menu is used when creating new Spectrum Sweeper objects, or editing existing Spectrum Sweeper objects. All menus are shown in the scanner's display as a three line window that can be scrolled up or down to access the various different parameters. The active parameter is always the middle parameter and is indicated by a flashing "⌘". The entire SWPR menu is shown below:

SWPR Parameter	Options	Description
Scan Lists	On or Off for Scan Lists 1-20	Sets membership in Scan Lists. Use ◀ ▶ keys to scroll through Scan Lists. Use SEL key to toggle Scan List membership. A "⌘" next to the Scan List number indicates that the object is mapped to that Scan List.
Type	All Bands or Pub Safety	Use ◀ ▶ to select All Bands or Public Safety. All Bands covers the entire frequency range of the scanner. Public Safety covers frequency ranges commonly used for public safety communications.
Sub-bands	◀ ▶, SEL	<p>Sub bands are available when using SWPR in All Bands or Public Safety mode. In All Bands, the sub bands are defined as follows:</p> <ul style="list-style-type: none"> <li>0: 25-54 MHz</li> <li>1: 108-137 MHz</li> <li>2: 137-174 MHz</li> <li>3: 216-300 MHz</li> <li>4: 300-406 MHz</li> <li>5: 406-470 MHz</li> <li>6: 470-512 MHz</li> <li>7: 764-806 MHz</li> <li>8: 806-869 MHz</li> <li>9: 896-1300 MHz</li> </ul> <p>In Public Safety, the sub bands are defined as follows:</p> <ul style="list-style-type: none"> <li>0: 33.4-46.5 MHz</li> <li>1: 151-170 MHz</li> <li>2: 453-467 MHz</li> <li>3: 764-806 MHz</li> <li>4: 851-869 MHz</li> </ul>
Tag	Alpha-numeric text	The alphanumeric display name for the SWPR object. Use the standard text entry method or QTXT to name the object.
L/Out	On or Off	Permanent lockout for the SWPR search. Also accessed by pressing FUNC L/OUT while the scanner is stopped on the SWPR object.
LED Mode	Solid or Flash	Controls whether the ALERT LED flashes or remains on solid when the ALERT LED is used.

SWPR Parameter	Options	Description
LED Color	0-7	Sets LED color to 0-7 as defined in the GLOB menu. By default, 0=LED Off, 1=Red, 2=Yellow, 3=Green, 4=Cyan, 5=Blue, 6=Magenta, 7=White.
Latch LED	On or Off	Normally the ALERT LED is active only while the object is receiving a transmission. When Latch is on, the ALERT LED will remain lit after the transmission is complete, unless overridden by a subsequent object that is also using the ALERT LED.
Backlight	On, Off or Flash	Controls whether the backlight should be on, off or flashing while the object is active.
Alarm	None, Chirp, Hi-Lo, Alert, Ring, 2-Chirp, Fast Hi-Lo, DTMF#	Sets the Audible Alarm for the SWPR object. When an Audible Alarm is selected, the selected alarm will play anytime the scanner stops for activity on the SWPR object while scanning.
Fav	On or Off	When On, the SWPR object is a member of the Favorites Scan List.
<b>EXPERT BELOW</b>		
Atten	On or Off	When on, applies 20 dB of attenuation to all hits received on the SWPR search. Useful in areas where interference from nearby strong signals is present.
Delay	On or Off	Controls whether a Delay is used to wait for reply traffic after a transmission on the SWPR search.
Delay Time	1-200	Sets the amount of time (in 100 millisecond intervals) for the wait for reply delay if Delay is On, e.g., 20=2 seconds.
Zeromatic	On or Off	When on, enhances the scanner's ability to lock on to the actual center frequency of a search hit instead of an adjacent frequency.
Special	On or Off	SWPR works by quickly sweeping the RF spectrum in 1 MHz increments to find nearby strong signals. If the 1 MHz sweep indicates that activity is present in the 1 MHz range, SWPR sweeps that range to find the source.
Search Dir	Up or Down	Sets search direction used when SWPR object is active.
Hit Count	Numeric value	Increments each time a transmission is received on the SWPR object. Global "Hit Counts" must be set to ON. Press the <b>Dflt</b> softkey to reset to 0.

## Appendix A - Remote Control Protocol



*NOTE: GRE provides Memory File Format, CCDump Protocol, PC/IF Clone Protocol and Remote Control Protocol Specifications (the "Specifications") AS IS for the convenience of scanning hobbyists and programmers who wish to develop software applications for use with the PSR-500. Use of the Specifications shall be AT YOUR OWN RISK. GRE does not provide Memory File Format, CCDump Protocol, PC/IF Clone Protocol and Remote Control Protocol technical support. Should you require assistance with the Specifications, we encourage you to visit one of the many PSR-500 User Group forums on the Internet. By using the Specifications, you agree to these terms.*

The PSR-500 includes a simple remote control interface protocol (RCIP) that is suitable for use with a PC application designed to provide a remote control and display capability. The ideal PC application should provide a means by which a user can interact with a visual representation of the scanner's keypad and display.

Remote Control Mode is active at all times, and does not require that the radio be placed in any special remote mode in order for it to be used.

The basic remote control command/response format is as follows:

```
<STX><msgCode><msgData><ETX><sum>
```

where:

<STX> is an ASCII "Start of Text" symbol (0x02)

<msgCode> is the code that represents the command or response message type

<msgData> is the data that accompanies a command or a response

<ETX> is an ASCII "End of Text" symbol (0x03)

<sum> is the sum of all bytes before sum but not including <STX>, and is sent with every command and response for error checking.

The following commands are supported in the RCIP:

## Get Status

Command:

```
STX A ETX <sum>
```

Response:

```
STX A
```

```
<mode> <sq> <battL> <battH> <rssiL> <rssiH>  
<zmL> <zmH> <ledR> <ledG> <ledB> <freqL> <freq2>  
<freq3> <freqH> <rxMode> ETX <sum>
```

NOTE: <battH> is ORed with 0x80 when on  
external power

sq:

bit 0: RF Squelch state

bit 1: Unmuted state

bit 2: /XF state (IMBE detect)

bit 3: HD2 state (in DG, P25 CC detect, in  
CTCSS/DCS, reverse burst/turn  
off code detect)

bit 4: HD5 state (CTCSS/DCS/NAC detect)

bit 5: set to 1 if Mobile (PSR-600), 0 otherwise

bit 6: set to 1 if bit 5 == 1 and backlight  
level is "Dim"

## Get LCD

Command:

```
STX L ETX <sum>
```

Response:

```
STX L <lcd0> <lcd1> ... <lcd63> <icons1>  
<icons2> ETX <sum>
```

NOTE: <icons1> and <icons2> are bitmapped representations of display icon status, as follows:

icons1:

bits 0-2: RSSI bars level, 0-5

bit 3: S icon

bit 4: Batt icon ON

bit 5: Batt icon BLINKING

icons2:

bit 0: 'F' icon

bit 1: 'G' icon

bit 2: 'A' icon

bit 3: 'T' icon

bit 4: up arrow icon

bit 5: down arrow icon

bit 6: LCD backlight status

## Send Key

Command:

STX K <keycode> ETX <sum>

Response:

(no response)

Key codes for the Send Key command are as follows:

Key	Code	Key	Code	Key	Code	Key	Code
SCAN	15	2	27	▲	7	F2	25
FUNC	1	3	21	7	35		32
MAN	3	◀	14	8	29	SRCH	10
WX	17	ATT	26	9	23	L/OUT	5
SEL	8	4	34	F3	19	PGM	12
FAV	4	5	28	▼	9	ENT	18
PRI	11	6	22	0	30	F1	31
TUNE	16	▶	2	.	24		

Key	Code	Key	Code	Key	Code	Key	Code
1	33	PSE	6	CL	36		

NOTE: To initiate the "press and hold" action for the Light key, send code 32 ORed with 0x80 (value is 0xA0)

## Tune

Command:

```
STX T <freq0> <freq1> <freq2> <freq3> <rxmode>
ETX SUM
```

Response:

(no response)

## Appendix B - CCDump



*NOTE: GRE provides Memory File Format, CCDump Protocol, PC/IF Clone Protocol and Remote Control Protocol Specifications (the "Specifications") AS IS for the convenience of scanning hobbyists and programmers who wish to develop software applications for use with the PSR-500. Use of the Specifications shall be AT YOUR OWN RISK. GRE does not provide Memory File Format, CCDump Protocol, PC/IF Clone Protocol and Remote Control Protocol technical support. Should you require assistance with the Specifications, we encourage you to visit one of the many PSR-500 User Group forums on the Internet. By using the Specifications, you agree to these terms.*

Your PSR-500 features a trunked control channel decoding utility called CCDump. When CCDump is turned on, the scanner sends decoded trunking control channel information and SAME weather alert data to the PC/IF port. This data can be displayed using any simple terminal application, or, read by third party application software for additional analysis and decoding.

CCDump is turned off by default in the PSR-500. To activate CCDump, press the PGM key, then press FUNC, then press the GLOB softkey to access the Special Global Settings menu. Scroll down using the ▼ key until CCDUMP: No is shown on the middle line of the LCD display. Press the ◀ ▶ keys to toggle CCDump on or off. Press the SAVE softkey when finished to save the change in the radio's configuration memory.

To view CCDump data, connect the radio to a personal computer using the USB PC/IF cable. Start a terminal program or your third party application software. Configure the communications parameters for "115200, N, 8, 1" as follows:

COM Port: The COM port number assigned to the USB cable by your computer. If you are running a Windows operating system, you can find this information under "Ports" in the Device Manager.

Parity: None

Baud Rate: 115,000 bits per second

Word: 8 bits

Stop Bits 1

Basic CCDump data includes the system type, the Object ID of the TSYS object (if applicable), and the “raw” control channel messages as they are transmitted by the system. This data is delimited by “:” symbols. Basic CCDump data is sent to the PC/IF port under the following conditions:

- In TUNE mode, when the radio is tuned to a trunking control channel
- In TSYS analysis mode, when the radio is tuned to an active control channel in the TSYS channel list

Expanded CCDump data includes all of the data that is provided in the Basic CCDump data display, and provides additional human-readable decoding of certain trunked control channel messages. Expanded CCDump data is sent to the PC/IF port under the following condition:

- When the radio is monitoring a trunked control channel while in MAN or SCAN modes

Under certain circumstances the CCDump output may interfere with the cloning process. If you experience problems with cloning, ensure that CCDump is turned off by pressing the PGM key, then the FUNC key, then the GLOB softkey, then scrolling to the CCDump menu item. If necessary, turn CCDump off by pressing the left or right arrow key, then press the Save softkey to save the setting.

The following describes the CCDump message format for the supported modes:

```
<Msg Type>:T<xxxx>:<CC data>[:<Expanded CCDump description>]
```

```
<Msg Type>= always 3 ASCII chars:
      WXS (WX SAME)
      WXT (WX 1050Hz tone)
      P25, M36, LTR, EDW, EDN
```

```
<xxxx> = the hexadecimal representation of the TSYS's File
      System ID (for WXS and WXT, this is the current Wx
      Chan 0-6, if in TUNE mode, "AAAA")
```

```
<CC data> = the "osw" from the CC. The format necessarily
      depends on the system type:
```

```
P25: <X1><X2><X3><X4><X5><X6><X7><X8><X9><XA><XB><XC>
      <X1> - <XC> = 12 2-digit hexadecimal bytes
      from the last msg
```

```
M36: <cmd> <dir> <id>
```



<cmd> = 3-digit (10-bit) hex "command" value  
<dir> = direction bit  
<id> = 4-digit (16-bit) hex "id" value

LTR: <RR>: <A>-<GG>-<HH>-<III>-<FF>  
<RR> = repeater on which the msg was received  
<A> = area  
<GG> = Goto/In-Use repeater #  
<HH> = Home Repeater #  
<III> = Group ID  
<FF> = Free Repeater #

EDW: <W>: <ccc> <ppppppp>  
<W> = which of the two blocks (0 or 1) in the msg  
pair this is <ccc> = command value. Represents a  
variable # of bits from the received data (since  
commands are variable length)  
<payload> = remainder of msg, after removing the  
<ccc> command value

EDN: <W>: <ccc> <ppppppp>  
<W> = which of the two blocks (0 or 1) in the msg  
pair this is  
<ccc> = command value. Represents a variable # of  
bits from the received data (since commands are  
variable length)  
<ppppppp> = remainder of msg, after removing the  
<ccc> command value

WXS: <SAME Message> One code at a time

WXT: "1050Hz Detect"

<decoded description> = If present, how the radio SW  
interpreted the msg.

## Appendix C - Frequency, Step and Mode Specifications

<u>Frequency Range</u>	<u>Step Size</u>	<u>Default Mode</u>
25.0000 - 26.9600 MHz	10 kHz AM	
26.9650 - 27.4050 MHz	10 kHz AM	
27.4100 - 29.5050 MHz	5 kHz AM	
29.5100 - 29.7000 MHz	5 kHz FM	
29.7100 - 49.8300 MHz	10 kHz FM	
49.8350 - 54.0000 MHz	5 kHz FM	
108.000 - 136.9916 MHz	8.33 kHz AM	
137.000 - 137.995 MHz	5 kHz FM	
138.000 - 143.9875 MHz	12.5 kHz FM	
144.000 - 147.9950 MHz	5 kHz FM	
148.000 - 150.7875 MHz	12.5 kHz FM	
150.800 - 150.8450 MHz	5 kHz FM	
150.8525 - 154.4975 MHz	7.5 kHz FM	
154.5150 - 154.6400 MHz	5 kHz FM	
154.6500 - 156.2550 MHz	7.5 kHz FM	
156.2750 - 157.4500 MHz	25 kHz FM	
157.4700 - 161.5725 MHz	7.5 kHz FM	
161.6000 - 161.9750 MHz	5 kHz FM	
162.0000 - 174.0000 MHz	12.5 kHz FM	
216.0025 - 219.9975 MHz	5 kHz FM	
220.0000 - 224.9950 MHz	5 kHz FM	
225.0000 - 379.99375 MHz	6.25 kHz AM	
380.0000 - 419.987500 MHz	12.5 kHz FM	
420.0000 - 450.000000 MHz	5 kHz FM	
450.00625 - 469.99375 MHz	6.25 kHz FM	
470.00000 - 512.00000 MHz	12.5 kHz FM	
764.00000 - 766.996875 MHz	3.125 kHz FM	
773.00000 - 775.996875 MHz	3.125 kHz FM	
794.00000 - 796.996875 MHz	3.125 kHz FM	
803.00000 - 805.996875 MHz	3.125 kHz FM	
806.00000 - 823.987500 MHz	12.5 kHz FM	
849.00000 - 868.987500 MHz	12.5 kHz FM	
894.00000 - 901.987500 MHz	12.5 kHz FM	
902.00000 - 939.987500 MHz	12.5 kHz FM	
940.00000 - 960.000000 MHz	6.25 kHz FM	
1240.0000 - 1300.00000 MHz	6.25 kHz FM	

\*Excludes frequencies utilized by the Cellular Mobile Radiotelephone Service: 824-848.9875 MHz and 869-893.9875 MHz

## Appendix D - General Specifications

Item	Specification
Working Memory	1800 programmed objects using flexible "Scannable Object" system. Program and scan conventional channels, trunking talkgroups, limit searches, service searches, and Spectrum Sweeper configurations as "Scannable Objects" that are created, edited, grouped and scanned using common user interface conventions.
Virtual Scanners	21 Virtual Scanner (V-Scanner) folders, each capable of holding the entire contents of working memory, for a total storage capacity of over 37,800 objects.
Searches	7 preprogrammed dedicated service searches, 1 dedicated limit search. Any service or limit search can be programmed and scanned as an object alongside conventional channels and trunking talkgroups
Priority	Talkgroup and conventional channel priority, selectable priority sample rate and priority sample during trunking talkgroup call
Conventional Receiver Modes	AM, FM, NFM, CTCSS, DCS, P25 NAC
Trunking Receiver Modes	Motorola Type I/II/III Analog and Digital, GE/Ericsson/MA-COM EDACS Narrowband and Wideband, EF Johnson LTR
Receiver System	Triple conversion PLL super-heterodyne
1st IF	380.8 MHz (The 1st LO uses high side of receive frequency range for VHF and UHF Low/T, and low side of receive frequency range for >512 MHz)
2nd IF	21.4 MHz (The second LO uses low side of 1st IF)
3rd IF	455 kHz (The 3rd LO uses the low side of the 2nd IF)
Frequency Range	VHF Low 25.00000 - 54.00000 MHz VHF Aircraft 108.00000 - 136.99166 MHz VHF High 137.00000 - 174.00000 MHz 216.00250 – 224.9950 MHz 225.00000 – 299.93750 MHz UHF Low/T 300.00000 – 512.00000 MHz UHF High 796.00000 – 960.00000 MHz* 1240 .00000 – 1300.00000 MHz *Excludes frequencies utilized by the Cellular Mobile Radiotelephone Service

Item	Specification
Preprogrammed Service Searches	Marine Aircraft CB FRS/GMRS/MURS/DOT-STAR Public Safety Amateur Radio Railroad
Weather frequencies	162.400, 162.425, 162.450, 162.475, 162.500, 162.525, 162.550 MHz
Scanning Rate	Approximately 55 channels per second
Search Rate	Approximately 90 steps per second
Display	LCD with amber LED backlight, 4 lines of 16 characters each, plus 13 display icons
Zeromatic	Automatically zeroes receiver on correct frequency during searches
Audio Output	250 mW
Spectrum Sweeper Band Groups	<p>All Bands:  Group 0 (25 – 54 MHz)  Group 1 (108 – 136.99166 MHz)  Group 2 (137 – 174 MHz)  Group 3 (216.0025 – 299.9750 MHz)  Group 4 (300 – 405.9875 MHz)  Group 5 (406 – 470 MHz)  Group 6 (470.0125 – 512 MHz)  Group 7 (764-767, 773-776, 794-797, 803-806 MHz)  Group 8 (806 – 868.9875 MHz)*  Group 9 (896 – 960, 1240 – 1300 MHz)</p> <p>Public Safety Bands:  Group 0 (33.4-46.5 MHz)  Group 1 (151 – 170 MHz)  Group 2 (453 – 467 MHz)  Group 3 (764-767, 773-776, 794-797, 803-806 MHz)  Group 4 (806-869 MHz)*</p> <p>*Excludes frequencies utilized by the Cellular Mobile Radiotelephone Service</p>
Internal Speaker	36 mm 8 ohms dynamic
Operating Voltage	6 VDC (4 ea. "AA" alkaline, NiCAD or NiMH)
External Power and Charge Voltage	9 VDC 500 mA regulated power supply
Dimensions	Approximately 2.56(w) x 1.65(d) x 5.71(h) inches, 65 (w) x 42 (d) x 145 (h) mm

Item	Specification
Weight	Approximately 8.5 ounces, 240 grams (not including batteries and antenna)
Included accessories	GRE compact helical antenna, CD (includes Owner's Manual, Demo Remote Control software, USB cable drivers and V-Scanner data files), alkaline battery holder, NiCAD/NiMH battery holder, belt clip, USB PC/IF cable, AC to DC external power adapter
Memory backup	No backup battery required, utilizes non-volatile EEPROM memory

## Appendix E - About Trunked Radio Technologies

In communications, **trunking** is defined as the sharing of a small number of communications resources amongst a large number of users. Trunking is based on the basic principle that “not all users will need to communicate at the same time”.

The best example of trunking in communications is the typical telephone **private branch exchange**, or **PBX**, which is used in many businesses, hospitals, schools and other organizations to provide desktop telephone service to the people who work at a specific building or site.

A traditional PBX might consist of the individual telephones on the desktops in the building, the PBX switching equipment, and various connections to the public telephone switched network, or PSTN.

Consider a large office facility for a company with 500 employees, each one with a telephone on their desk. Using their telephone and the PBX, it is possible for any employee to call another employee’s extension in the office building, and, it is possible for any employee to make an outside call to any other telephone anywhere in the world.

It would certainly be cost prohibitive for each of these employees to have an individual outside telephone line just so they could get dial tone and make calls to other telephones beyond the company’s PBX. This is where trunking technology is applied.

Engineers study the needs of the company and its employees to determine the number of connections required to support the company’s requirements. In this example, a total of 50 outside lines may be provided to support the 500 employees who work at the site, again, based on the principle that not all users will need to communicate at the same time. These outside lines are shared, and assigned to users automatically by the PBX on an as-needed basis. If the engineers have done their jobs right, the number of outside lines that are provided will be adequate for almost all circumstances. Rarely, if ever, should a user in the building not have access to an outside line when needed, and the number of lines available is not overkill, such that money is wasted on unneeded excess capacity.

In radio, trunking works in a very similar way. Instead of each radio user or user group having their own dedicated radio channel, a small group of radio channels is shared amongst a

large number of radio users or user groups. In a typical trunked radio system, 20 radio channels can support the radio communications needs of a few thousand users.

Instead of dedicating individual radio channels to specific user groups, trunked radio systems utilize special, temporary “virtual” channels called talkgroups. Each talkgroup has a digital address that identifies it on a trunked radio system. In most trunked radio technologies, each portable or mobile radio has an individual digital address, much like the individual telephone extensions in a PBX system.

There are two basic types of trunked radio technologies in use today, “centralized control” and “distributed control”.

Systems with **centralized control** utilize one or more specialized computers called **controllers** to manage the operation of the trunked radio system. The controller is responsible for assigning radio channel resources to users and user groups as needed, that is, when a user needs to speak with another user or with a group of users. Centralized control trunked radio systems reserve one of the system channels for use as the **control channel**, and the remaining channels are used as voice or “traffic” channels. When a user needs to place a call on a system utilizing centralized control, they press the push-to-talk button on their radio, which causes their radio to send a short data message to the controller over the control channel, requesting that a voice channel, if available, be assigned to that user or user group for a voice call. The controller assigns an available voice channel to the call, and sends a data message out over the control channel signaling that user and all other members of the user’s talkgroup to switch to a voice channel and proceed with the voice communication.

Motorola, EDACS and P25 trunked radio systems all utilize centralized control. When monitoring a centralized control system, your scanner utilizes the data sent by the controller on the control channel to track the voice traffic for the talkgroups that you wish to monitor.

Systems with **distributed control** do not utilize a central controller to manage the assignment of radio channel resources. Each channel includes its own individual controller, and these controllers are all connected to each other over a data bus, such that every channel and controller on the system knows the status of the other channels and controllers at any given moment. In distributed control, there is no single dedicated control channel.

Each individual channel serves as a control channel for the users and user groups that are “homed” to that channel by sending out a subaudible data message simultaneously with voice traffic when needed.

The portable and mobile radios in a distributed control trunked radio system monitor their home channel when idle for data messages that include commands regarding activity for their talkgroup, and, in the event that the home channel is busy, a free channel elsewhere on the system that is available for communications if needed.

When a user in a distributed control system needs to speak, they press the push-to-talk button on their radio. If the home channel is not in use, the controller sends a data message out over the home channel that tells the other users in the talkgroup that a call is taking place on the home channel, and all the radios in the talkgroup transition to voice call mode on the home channel.

If the home channel is busy, it sends subaudible data messages over the home channel simultaneously with any voice traffic it is carrying. These subaudible data messages include a “free repeater” message that informs other radios homed to the channel of the next available free repeater that is not in use. When a user places a call by pressing the push-to-talk button in this scenario, the new call is placed on this free repeater, and the subaudible data message on the home is updated to include signaling that tells other users of the talkgroup that the talkgroup is now active on the free repeater. The other users switch to the free repeater and the voice call proceeds there.

LTR systems operate using distributed control. Your scanner utilizes the data sent by each controller on each channel to track the activity on an LTR system.



## Appendix F - About CTCSS, DCS and P25 NAC

CTCSS, DCS and P25 NAC are terms used to describe the different types of **selective squelch** that your PSR-500 is capable of utilizing with conventional, non-trunked radio channels.

In many cases, frequencies that are assigned to licensees are not licensed on an exclusive basis. This means that the transmitters and receivers operated in one licensee's radio system may be close enough geographically to another licensee that it is technically possible for the two licensees to hear radio traffic from each other's system. This is especially true for business radio users, however, it is not all that uncommon for different public safety licensees to be close enough to each other for one licensee's radio traffic to be heard by another licensee. Additionally, certain radio propagation events can sometimes allow radio signals to travel hundreds or thousands of miles beyond a licensee's service area, in some cases, making their radio transmissions receivable on the other side of the continent.

Reception of traffic from another radio user can be an undesirable situation, causing confusion and distraction.

Selective squelch is employed in transmitting and receiving equipment to limit reception to only those transmitters that are transmitting the correct encoded selective squelch signal. Much in the same way that a radio licensee can use selective squelch to block out foreign traffic from their radio receivers, you can use selective squelch on your PSR-500 to block undesired traffic from being received on your scanner. In addition to this basic selective squelch capability, your PSR-500 can search for and display the selective squelch type and squelch tones or codes in use on a particular frequency.

The three types of selective squelch available in the PSR-500 are as follows:

### **CTCSS**

CTCSS stands for Continuous Tone Coded Squelch System. In CTCSS, the transmitter sends a special, low level audio tone continuously while a transmission is in progress. This is known as a **subaudible** tone - the level and frequency are such that they are difficult or impossible to hear in a receiver's speaker. The receiver (or your scanner) will detect and decode this tone, and if it matches the programmed tone, the speaker will be unmuted and voice audio allowed to pass. If the tone is not

present, or an incorrect tone is found, the receiver will remain muted. Additionally, the PSR-500 can detect the CTCSS tone that is in use on a transmitter, and will allow you to store the tone value with a CONV object when a CTCSS transmission occurs.

It is possible to hear this tone if you listen with headphones. CTCSS sounds like a low, steady “hum” in the background of a voice transmission.

## **DCS**

DCS stands for Digital Coded Squelch. In DCS, the transmitter sends a special, low level data signal continuously while a transmission is in progress. This is known as **subaudible** data - the level of the data signal is such that the data is difficult or impossible to hear in a receiver’s speaker. The receiver (or your scanner) will detect and decode this data, and if it matches the programmed code, the speaker will be unmuted and voice audio allowed to pass. If the DCS code is not present, or an incorrect code is found, the receiver will remain muted. Additionally, the PSR-500 can detect the DCS code that is in use on a transmitter, and will allow you to store the code value with a CONV object when a DCS transmission occurs.

It is possible to hear this tone if you listen with headphones. DCS sounds like a low “purring” in the background of a voice transmission.

## **P25 NAC**

P25 NAC stands for Project 25 Network Access Code. NAC is a part of the APCO Project 25 digital radio standard, and works much like CTCSS or DCS to block undesired transmissions from a receiver. Project 25 voice information is sent as a series of data packets, and each packet includes the NAC that has been configured in the transmitter. A receiver can be programmed to unmute and play a voice transmission only when the packets from the transmitter include the correct NAC. Your scanner operates in the same way. Like CTCSS and DCS, it can detect the NAC that is in use on a transmitter, and will allow you to store the code value with a CONV object when a P25 transmission occurs.

## Appendix G - Finding More Information

### Learning About Scanning and your PSR-500

In recent years the Internet has become a powerful tool for both experienced and novice scanning hobbyists. There are many online discussion forums dedicated to the scanning hobby. In these discussion forums, you will find users helping other users with questions about radio systems, scanning receivers, antenna setups, and frequency listings for different areas.

One of the most useful resources on the Internet are discussion forums devoted to specific radio models. Frequently you will find other users who are willing to answer questions or help you solve problems with your scanning equipment.

In many cases a simple Web search using Google or other popular Internet search tools will help you find web sites and discussion forums where you can read more about the PSR-500, ask questions, and share your experiences with other PSR-500 users.

For starters, we recommend [www.radioreference.com](http://www.radioreference.com), where you will find a discussion forum dedicated to the PSR-500, along with dozens of other scanning discussion forums devoted to the scanning hobby.

We also suggest [groups.yahoo.com](http://groups.yahoo.com). Search the Yahoo Groups for PSR-500, and join groups that include active discussions related to the PSR-500.

And, be sure to visit [www.greamerica.com](http://www.greamerica.com) frequently for important news, software updates and information about exciting new GRE Scanning Receiver products and accessories!

### Finding Frequencies and Trunked System Information

Research is an important part of the scanning hobby. Before you can listen, you must first figure out what you want to listen to, and then perform the research necessary to obtain the conventional frequency or trunked radio system information needed to program your radio.

Sometimes, a simple Web search using Google or other popular Internet search tools is all that you need to get started. Try searching on “<name of city or county> scanner frequencies” or “<name of city or county> frequencies” (omitting the quotation marks and < > symbols) to locate personal web pages with

information about scanning in the specified areas. We also suggest [www.radioreference.com](http://www.radioreference.com), which includes an extensive database of conventional and trunked radio system data for locations all over the USA and the world.

One of the more enjoyable aspects of the scanning hobby is finding new frequencies on your own. Your PSR-500 includes powerful Limit Search (LMIT) and Service Search (SRVC) search capabilities that will help you find active frequencies in your area, and a Spectrum Sweeper (SWPR) that quickly searches through selected frequency bands to find nearby transmitters.

## Index

Abbreviations, object.16.....	
AC power.32.....	
Accessories included with PSR-500.22.....	
Alarms, audible.70.....	
Alert LED.70.....	
Alphanumeric Information, how to enter.89.....	
Antenna, how to install.27.....	
Audible Alarms.70.....	
AutoMove LTR home repeaters.68.....	
Background, OOUI.10.....	
Batteries, how to install.26.....	
Battery type, how to set.28.....	
Belt clip, installation and use.31.....	
Birdie frequencies.94.....	
Browsing Objects.46.....	
Care.95.....	
CCDump .....	119
Cloning Your Radio to Another PSR-500 or PSR-600.89.....	
CONV (Conventional Channel), creating your first.34.....	
CONV Menu Reference.103.....	
CTCSS, about.129.....	
CTCSS, DCS and P25 NAC, about.129.....	
DCS, about.130.....	
Default Scan List, how to set.65.....	
Deleting Objects.66.....	
Display Icons, understanding.23.....	
DUPE, how to use to speed up object entry.43.....	
Earphones, using.31.....	
Enabling and disabling Scan Lists.58.....	
External antenna, using.30.....	
External speaker, using.31.....	
Familiarization with your PSR-500.20.....	
FCC regulations.17.....	
Features.8.....	
Filtering By Object Type.61.....	
Finding more information.131.....	
Finding objects.60.....	
First Time Startup.26.....	
Five Way Pushbutton Pad.24.....	
Front View, PSR-500.20.....	
Get LCD command.....	116
Get Status command.....	116
Getting Started.26.....	
GLOB Menu Reference.100.....	

Grouping Objects with Scan Lists.	55
Headphones, using.	31
Hit Counters.	70
In Case of Fault.	95
Initializing Global Parameters to Factory Defaults.	96
Initializing the Scanner to Factory Defaults.	97
Introduction.	7
Keypad, Understanding.	24
LED, Alert.	70
Limit and Service search modes, dedicated.	76
Limit Search Object (LMIT).	49
Listening safely.	29
LMIT Menu Reference.	109
Lockout, object.	61
Lockout, permanent.	63
Lockout, search.	63
Lockout, talkgroup from Wildcard hit.	64
Lockout, temporary.	61
Low Battery Warning.	29
LTR AutoMove home repeaters.	68
Manual, about.	16
Mapping Objects to Scan Lists.	57
Memory Usage, how to display.	48
Menu Reference Tables.	99
Menu reference, detailed.	99
Multi-Site.	66
Naming Scan Lists.	58
Numeric Keypad.	24
Object ID, direct access.	47
Object Numbering, about.	47
Object Oriented Scanning, things to remember.	15
Object Oriented Scanning, what is.	14
Object Oriented User Interface, overview of.	10
Objects, how to create first.	34
Objects, how to delete.	66
Operation Keys.	25
P25 NAC, about.	130
Power, external.	32
Power-On Configuration Key Sequences.	93
Powering on.	28
Priority Scan.	68
Priority Scan Mode, turning on or off.	69
Priority Scan, CONV.	69
Priority Scan, TGRP.	69
Priority, turning on or off for objects.	69
Priority, weather.	80

QuickText.91.....	
QuickText, how to customize.92.....	
QuickText, how to use.91.....	
Rear View, PSR-500.21.....	
Remote Control Protocol.....	115
SAME Entry Examples.82.....	
SAME Location and Event Codes, how to enter.83.....	
SAME Standby Mode.81.....	
SAME Standby Mode, how to enter.86.....	
Scan Lists, enabling and disabling.58.....	
Scan Lists, how to group objects.55.....	
Scan Lists, mapping objects to.57.....	
Scan Lists, naming.58.....	
Scanning Legally.18.....	
Scanning Operation, basic.44.....	
Search modes, dedicated.72.....	
Search Object Types.48.....	
Searching For Objects Using FIND.60.....	
Send Key command.....	117
Softkeys.24.....	
Specifications, Frequency, Step and Mode.122.....	
Specifications, general.123.....	
Spectrum Sweeper (SWPR) Mode, dedicated.72.....	
SRVC (Service Search Object), creating your first.53.....	
SRVC Menu Reference.....	111
Standard Text Entry Method and QuickText.89.....	
Startup Topics, advanced.46.....	
Startup Topics, more advanced.60.....	
SWPR (Spectrum Sweeper Object), creating your first.50...	
SWPR Menu Reference.....	113
Text Entry.90.....	
TGRP (Talkgroup), creating your first.38.....	
TGRP Menu Reference.105.....	
Traffic safety.30.....	
Troubleshooting.96.....	
Troubleshooting Chart.96.....	
Trunked Radio Technologies, about.126.....	
TSYS (Trunked System), creating your first.38.....	
TSYS Menu Reference.107.....	
Tune command.....	118
TUNE mode, dedicated.74.....	
Unpacking.26.....	
Using Weather Modes.79.....	
V-Scanner Folder, how to load to main memory.88.....	
V-Scanner Folder, how to save main memory to.88.....	
V-Scanner Folders, how to erase.89.....	

V-Scanner Storage, how to use.86.....  
Vehicle DC power, using.32.....  
Warranty .137.....  
Weather Priority Mode.80.....  
Weather Radio Mode .80.....



## Warranty

### Limited Warranty

#### General

GRE America, Inc. warrants all parts of each new product to be of sound design, good material and workmanship, and will repair or exchange any parts proven to be defective under normal use at no charge for a period of 12 months from the date of sale to the end user.

GRE America will correct defects. There will be no charge for labor for a period of 12 months from the date of original sale, except as provided below. Overtime premiums and/or expedited handling and shipping costs must be paid by the owner.

An enclosed Warranty Card is included with each unit of purchase. We request the Warranty card be filled and return back to GRE America to validate the Warranty of your purchase along with Proof-of-purchase or you may also register online using the link below.

Online Product Registration is also available at <http://www.greamerica.com/register>

#### Warranty Limitations

This warranty does not apply to equipment or parts that have been subject to accident, abuse, incorrect service, alterations, service by non-authorized service personal, misuse.

A copy of the purchase receipt must be supplied or validated Warranty Registration must be on GRE database either by mail or through online when requesting for service.

Equipment must be sent to GRE America at the owner or dealer's expense and will be returned via surface carrier at no cost to the owner.

This warranty is strictly limited to the terms indicated herein, and no other warranties or remedies thereunder, express or implied, shall be binding on GRE America.

#### Warranty Returns

RETURN DEFECTIVE PRODUCTS TO YOUR DEALER OR CALL GRE AMERICA FOR A RETURN AUTHORIZATION NUMBER (RMA). YOU SHOULD HAVE A COPY OF YOUR ORIGINAL RECEIPT TO VERIFY DATE PURCHASE. UNIT IN WHICH THE WARRANTY HAS EXPIRED MAY BE SERVICED AT A FIXED RATE + PARTS FOR FACTORY REPAIRS. RETURN SHIPPING FOR UNITS UNDER WARRANTY WILL BE PAID BY GRE AMERICA. SHIPPING FOR UNITS OUT OF WARRANTY WILL BE PAID BY THE SENDER IN BOTH DIRECTIONS. AN RMA# OUTSIDE THE BOX NEXT TO THE SHIPPING ADDRESS MUST BE ACCOMPANIED WITH ALL UNITS BEING RETURN BACK TO GRE AMERICA. RETURNS WITHOUT RMA# WILL DELAY IN PROCESSING YOUR WARRANTY OR NON-WARRANTY REPAIRS.

#### **GRE America, Inc.**

425 Harbor Blvd.

Belmont, CA 94002 U.S.A

Ph: (650) 591-1400 . Fax: (650) 591-2001

Website: <http://www.greamerica.com>

Online Registration: <http://www.greamerica.com/register>

# RadioReference.com

Your Complete Reference Source

[www.radioreference.com](http://www.radioreference.com)

**RADIOREFERENCE.COM** IS THE WORLD'S LARGEST RADIO COMMUNICATIONS WEBSITE, WITH A COMPLETE FREQUENCY AND TRUNKED RADIO SYSTEM DATABASE. COME SEE WHAT FREE SERVICES WE HAVE TO OFFER TO THE COMMUNITY:

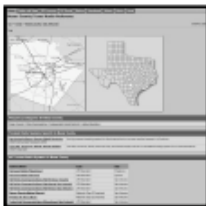

### The RadioReference Database

Includes a complete frequency database, trunked radio system information, FCC license assignments, 10 Code lists, agency maps, files, downloads, and detailed information for most public safety, military, and local government communications systems.



### The RadioReference Discussion Forums

Where over 120,000 members discuss radios, scanning, trunking, decoding, antennas, specialty radio topics, and location specific information.



### The RadioReference Wiki

The most comprehensive reference source of radio communications reference information – the de-facto encyclopedia for the radio communications community.

**FOR ONLY \$7.50 A QUARTER, RADIOREFERENCE.COM ALSO PROVIDES PREMIUM SUBSCRIPTIONS, WHICH ENTITLES PAID MEMBERS ACCESS TO:**

- The RadioReference.com Web service, to allow software applications to program a scanner directly from the RadioReference Database.
- PDF Downloads of database information for easy printing.
- MyRR – personalization for keeping track of your local information.
- Special database searches to make finding radio communications data easier.

**COME SEE WHY WE ARE THE #1 RESOURCE FOR THE RADIO COMMUNICATIONS COMMUNITY!**